

ROOM  
IN  
ROOM

2024

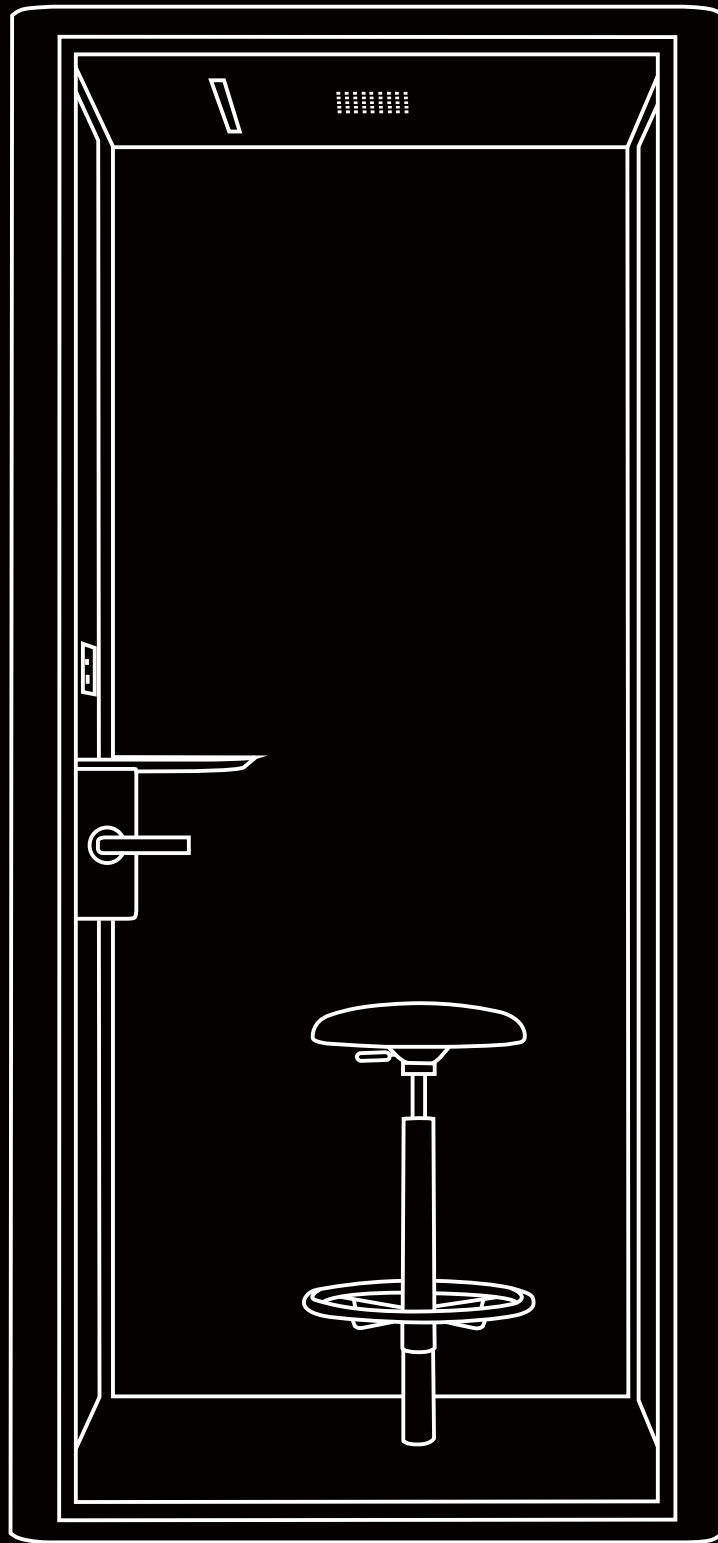

**UVO**

**MO BOX**

## UVO Group

UVO was founded in Hong Kong in 2017, that is a cutting-edge brand enterprise headquartered in Hong Kong that focuses on interior and exterior wall and smart modular space product system, integrating technical R&D, design, innovation, sales and services.

Through in-depth understanding of the international mainstream space product concept, and through full market research on the local Asian market, especially in view of the use habits of the Greater China and Southeast Asia market, we have developed a number of indoor and outdoor wall and smart modular space product systems, which perfectly interpret the brand concept and market positioning of UVO.

## MO BOX

UVO team has focused on the development of offices planning and implementation for years. The ideal office environment should be a total solution for enterprises, employees and owners, rather than intractability. MO BOX breaks down from the traditional concept, it is an integrated module, considering the function and personnel headcount in each space, and the four elements of lighting, electricity, sound insulation and ventilation.

As a whole, it offers the advantages of timeliness, convenience, mobility and reusability. It makes the layout of office space as simple as building blocks. When function or space needs change, reconstruction takes just a few days. Currently, we have choices of standard MO BOX rooms in different sizes, they can satisfy single person or multi-person coworking needs. At the same time, rooms can also be customised with different themes and sizes to meet more personalized requirements depending on the function of the space.

## Phone

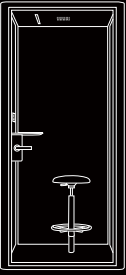

W950\*D950\*H2200mm

## Solo-A



W1050\*D1200\*H2200mm

## Solo-L



W1200\*D1200\*H2200mm

## Solo-H



W1200\*D1200\*H2200mm

## Live

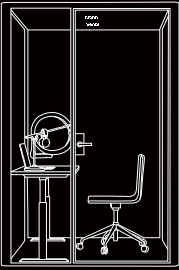

W1575\*D1200\*H2200mm

## Relax

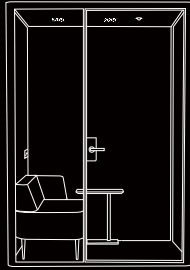

W1575\*D1200\*H2200mm

## Chat



W1575\*D1200\*H2200mm

## Solo Plus



W1770\*D1770\*H2200mm

## Cowork

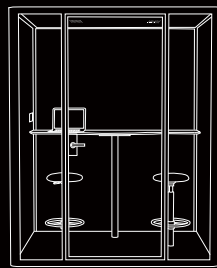

W1750\*D1200\*H2200mm

## Talk



W2200\*D1200\*H2200mm

## Talk Plus

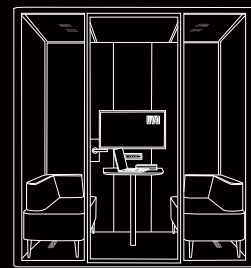

W2200\*D1500\*H2200mm

## Meeting



W2200\*D1770\*H2200mm

## Meeting BF

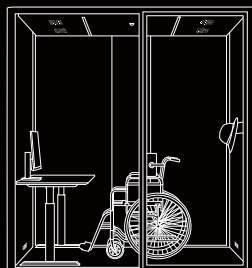

W2200\*D1770\*H2200mm

## Meeting Plus

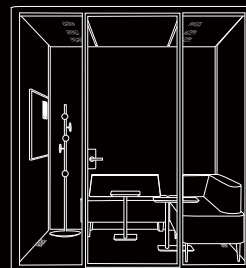

W2200\*D2200\*H2200mm

## Conference

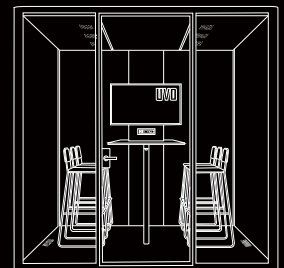

W2400\*D2400\*H2200mm

# Phone

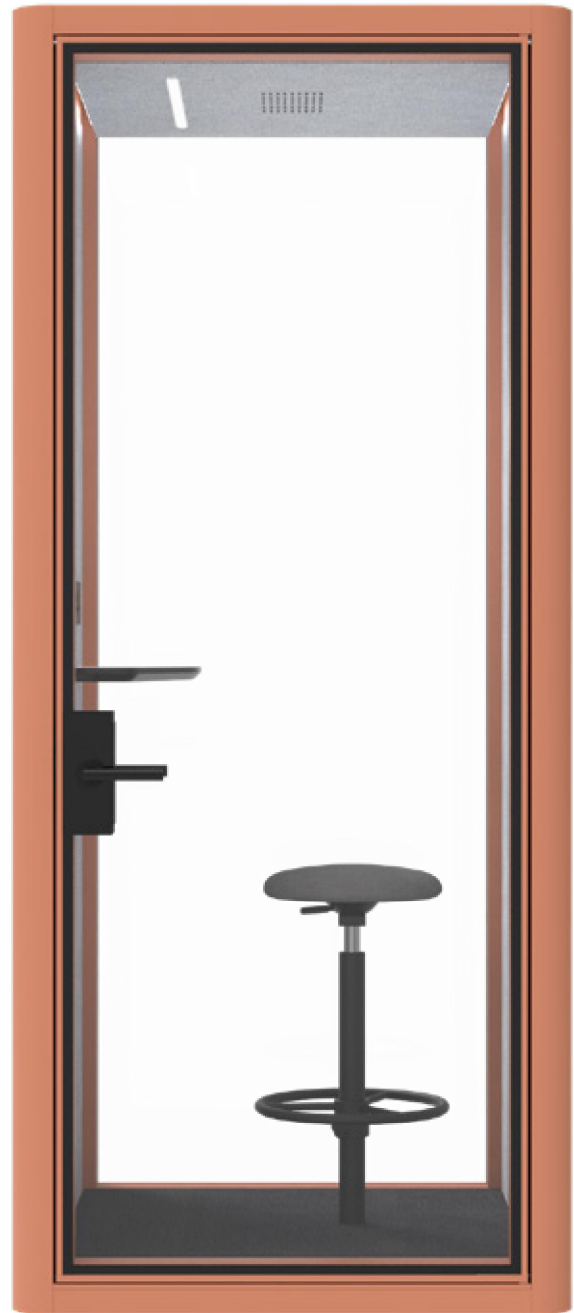

**LISTEN** to the call from the heart.

Phone gives you the privacy you need to conduct a focused conversation.

A perfect studio with soft light, fresh air and convenient power socket brings incomparable experience to users who need a break-time from the noisy world.

## Vertical View

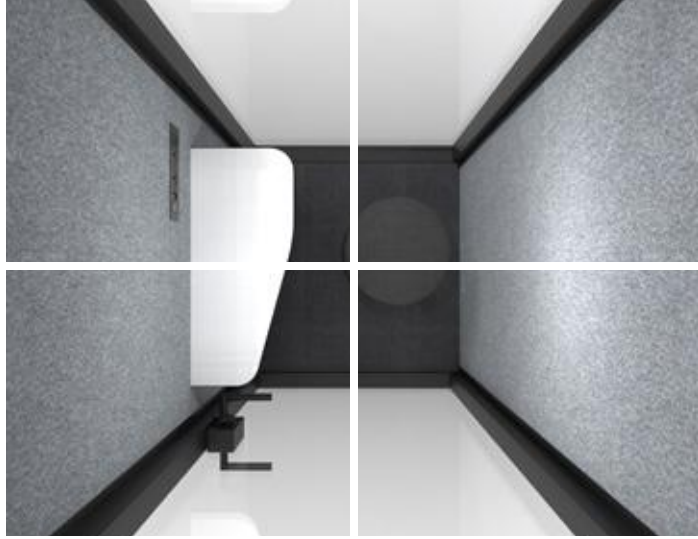

Outer:W950\*D950\*H2200/2320mm  
Inner:W820\*D820\*H2070mm



Phone collection is for privacy workspace . A highly insulated sound system allows you to talk freely and avoid interrupting noises, while also ensuring privacy. The space utilization is high, and it can be dismounted, moved and re-built circularly. When user need to work alone , think , or call , Phone is undoubtedly the best choice . It's as simple as putting up a "Do Not Disturb" sign . Simply go into the Phone to find your own time.It offers a great space for a Phone caller private work. Keep the office flexible and take privacy with you wherever and whenever you want.

# Phone



# Phone



**Private**

**Quiet**

**Movable**

**Easy to Install**

**Quick shipment**

## Product info

### Size

Outer:W950\*D950\*H2200/2320mm

Inner:W820\*D820\*H2070mm

Packing / Volume: W2300\*D800\*H1200 mm /2.3m<sup>3</sup>

### Other

Including table, Without chair

### Ceiling/Floor

Aluminum frame; Integrated ceiling with inner regular color PET; Movable bottom with carpet

### Wall/Door

SideA1/C1: steel panel with same color of frame; SideA2/C2: PET acoustic panel; side B:11mm laminated glass, side D : 11mm laminated glass with hidden frame door (Optional concealed door closer)

### Lighting

8W strip light at 2 sides; 8W strip light in the middle of ceiling;Motion sensor for ventilation fan and atmosphere light.Default delay of 5 minutes for automatic off.

### Control

Including integrated switch panel system(Default physical switch controls main lighting); Optional central control panel system.







### Fresh air

88m<sup>3</sup>/h (A ventilation time of 57s)

### Weight

Net weight:337kg

Packing weight:420kg

-  Silent room
-  Soundproof
-  Acoustic panels
-  LED
-  110-240V
-  USB



# Phone

Phone collection is for privacy workspace .

The space utilization is high, and it can be dismantled, moved and rebuilt circularly. When user need to work alone, think, or call, Phone is undoubtedly the best choice.

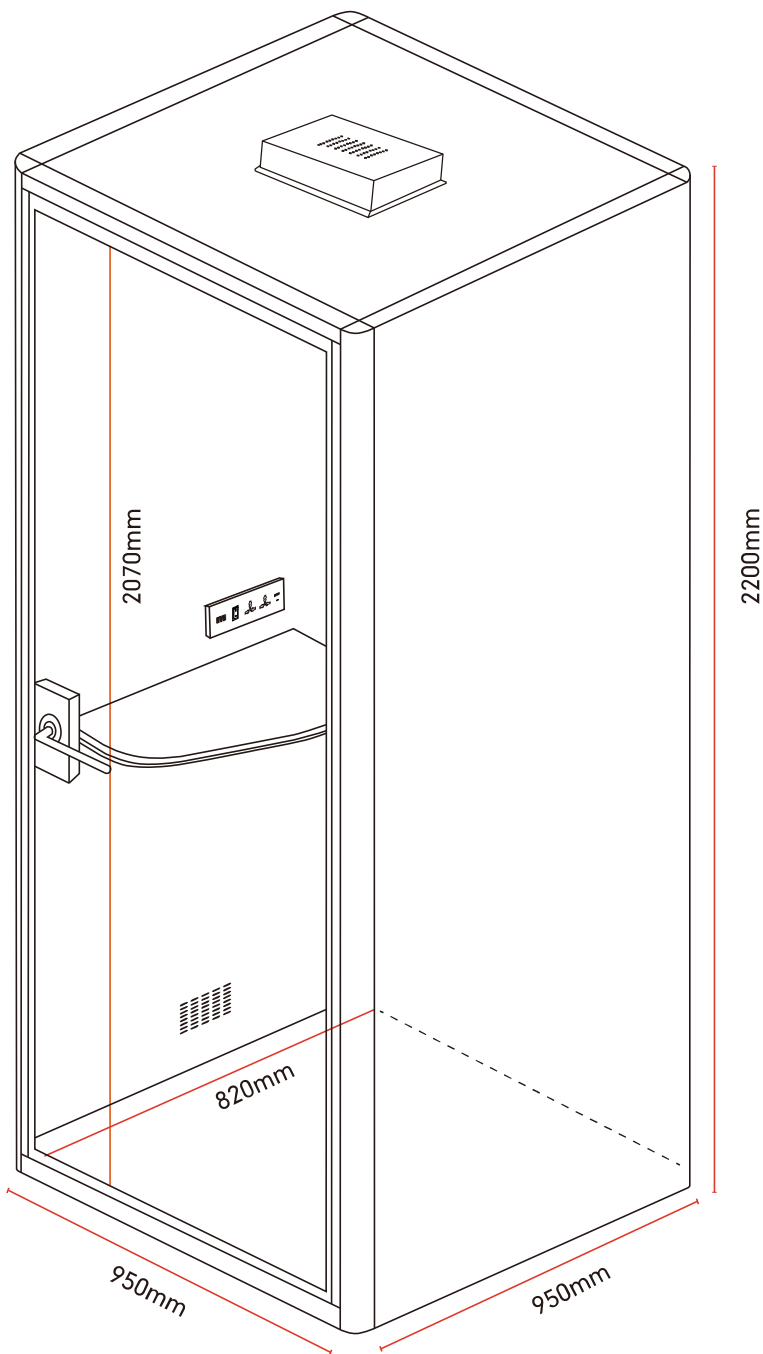

FRONT VIEW

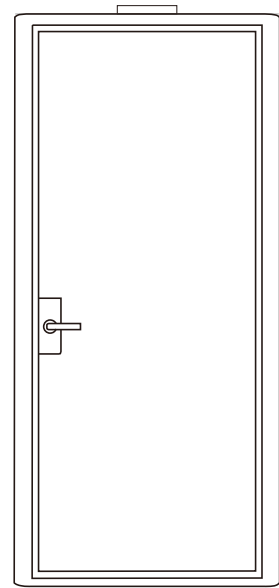

REAR VIEW

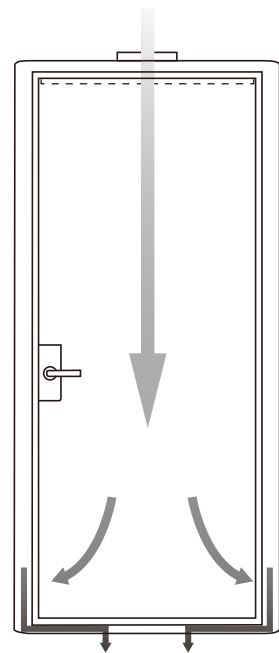

# Solo A



From a different perspective, there may be different perspectives on work.

Change your work posture at any time and take some time to breathe during busy time.



---

Outer:W1050\*D1200\*H2200/2320 mm  
Inner:W920\*D1070\*H2070 mm

## Vertical View

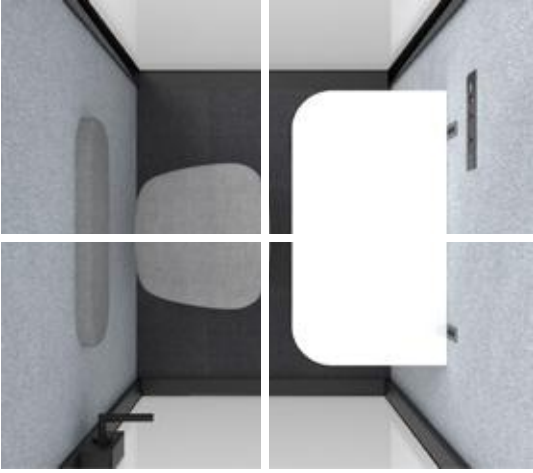

---

From a different perspective, there may be different perspectives on work.  
Change your work posture at any time and take some time to breathe during busy time.

# Solo A

---

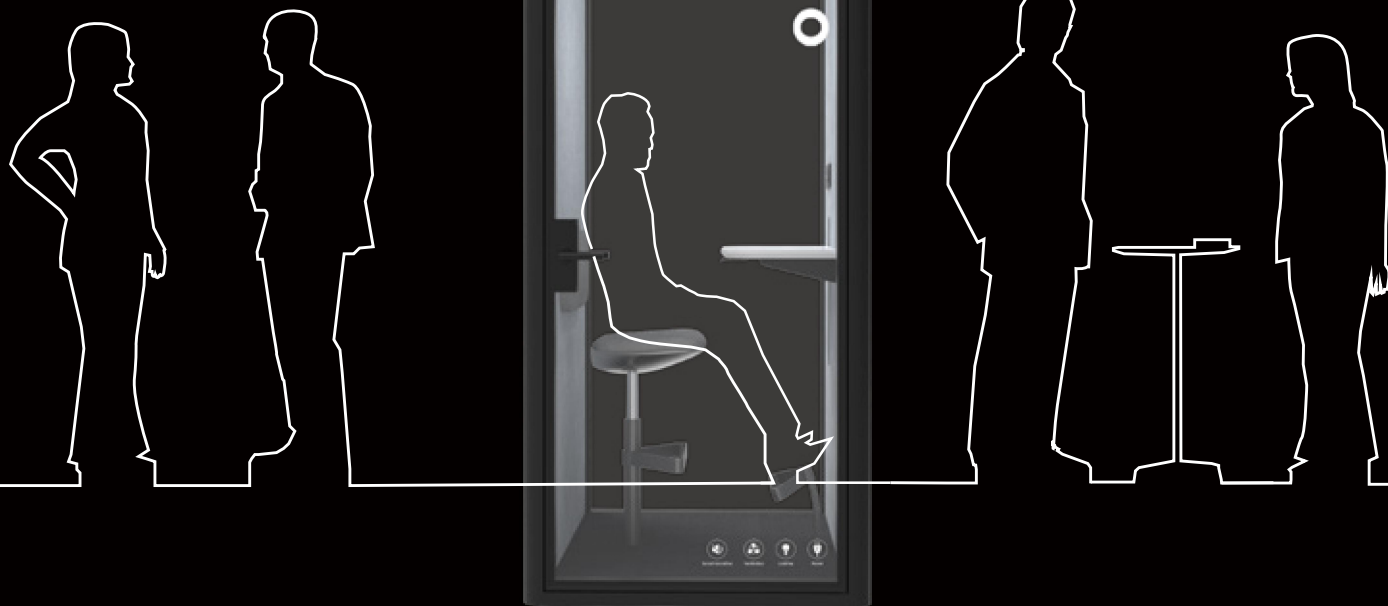
**Private****Quiet****Movable****Easy to Install****Quick shipment**

## Product info

### Size

Outer:W1050\*D1200\*H2200/2320mm

Inner:W920\*D1070\*H2070mm

Packing / Volume: W2300\*D840\*H1400 mm /2.8m<sup>3</sup>

### Other

Including fixed table ( Optional adjustable table), Without cushion, chair, pedal

### Ceiling/Floor

Aluminum frame; Integrated ceiling with inner regular color PET;

Movable bottom with carpet.

### Wall/Door

SideA1/C1: steel panel with same color of frame; SideA2/C2: PET acoustic panel; side

B:11mm laminated glass, side D : 11mm laminated glass with hidden frame door

(Including concealed door closer)

### Lighting

12W strip light in the middle of ceiling; Motion sensor for ventilation fan and atmosphere light.

Default delay of 5 minutes for automatic off.

### Control

Including integrated switch panel system(Default physical switch controls main lighting);

Optional central control panel system.

### Fresh air

100m<sup>3</sup>/h(A ventilation time of 71s)

### Weight

Net weight:460kg

Packing weight:550kg

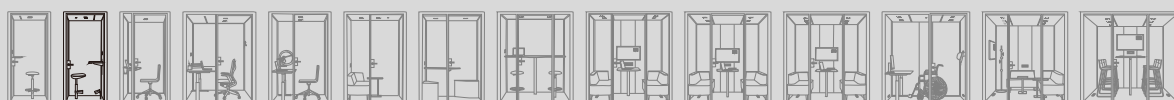
 Silent room Soundproof Acoustic panels LED 110-240V USB

# Solo A

From a different perspective, there may be different perspectives on work. Change your work posture at any time and take some time to breathe during busy time.

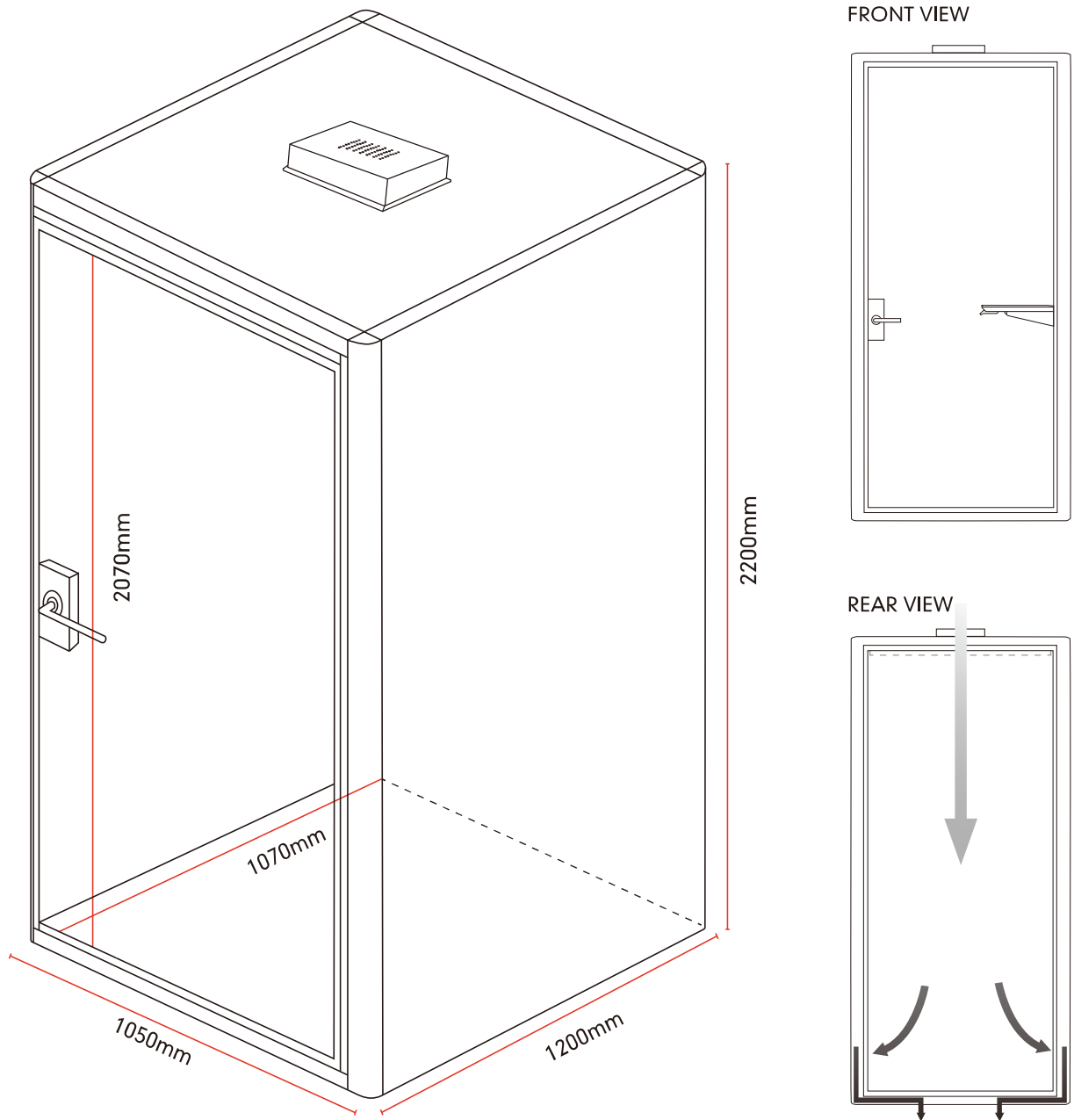

# Solo

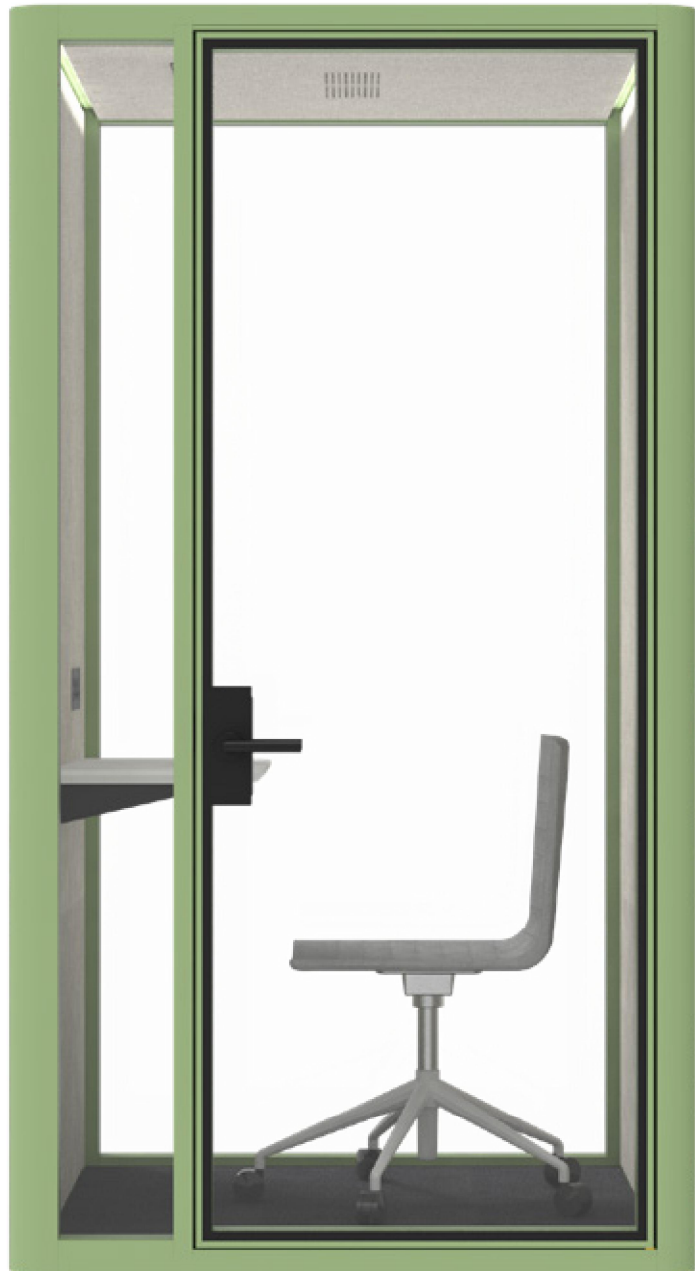

**LEARN** to explore by yourself . When we graduate from school and enter into society, the first skill we need to learn is independent thinking. Just like the guitar Solo, it brings a breath taking melody to the audience.



Outer:W1200\*D1200\*H2200/2320mm  
Inner:W1070\*D1070\*H2070mm

## Vertical View

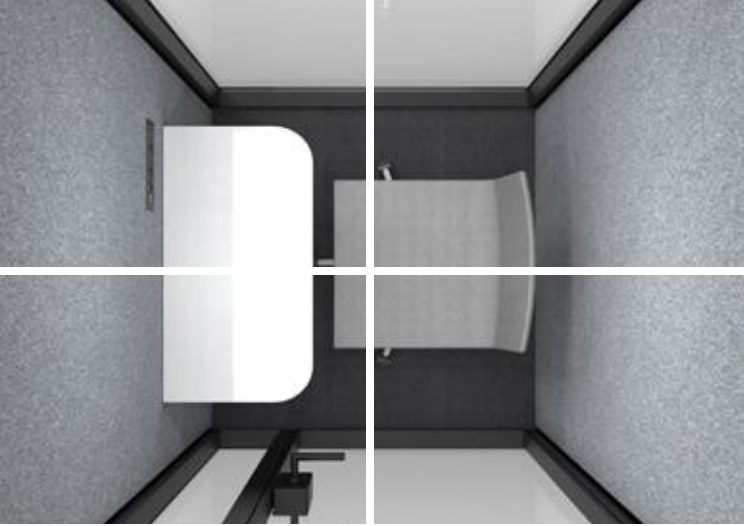

Unlike the Phone , which focuses only on call making , Solo can be used in a more integrated way , both as an enhanced Phone Booth and as a mobile work platform. When illuminated by the fascinating LED system mounted with the ceiling module , the user can be seen in a dreamy office space,complete with a comfortable fresh air system,and feel free to stay in Solo all day. Every time we sit in a solitary space and think , we are rewarded with a precious result of thought . It's time to let go of your mind and embrace a new life.

# Solo

# Solo

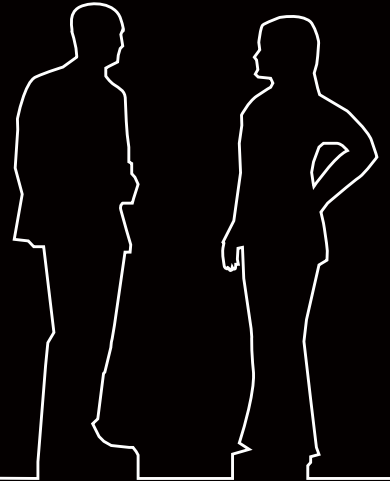
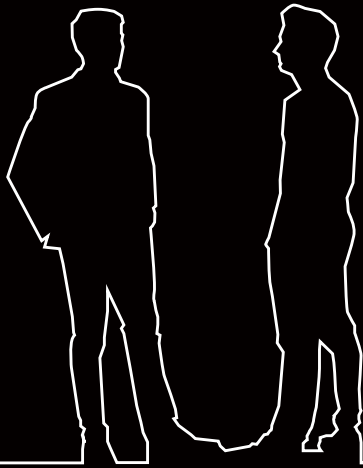

**Private**

**Quiet**

**Movable**

**Easy to Install**

**Quick shipment**

## Product info

### Size

Outer:W1200\*D1200\*H2200/2320mm

Inner:W1070\*D1070\*H2070mm

Packing / Volume: W2300\*D840\*H1400 mm /2.8m<sup>3</sup>

### Other

Including fixed table ( Optional adjustable table), Without chair

### Ceiling/Floor

Aluminum frame; Integrated ceiling with inner regular color PET;  
Movable bottom with carpet.

### Wall/Door

SideA1/C1: steel panel with same color of frame; SideA2/C2: PET acoustic panel;  
side B:11mm laminated glass, side D :11mm laminated glass with hidden frame  
door (Optional concealed door closer)

### Lighting

12W strip light at 2 sides; 12W strip light in themiddle of ceiling; Motion sensor for ventilation fan and  
atmosphere light.Default delay of 5 minutes for automatic off.

### Control

Including integrated switch panel system(Default physical switch controls main lighting);  
Optional central control panel system.

### Fresh air

100m<sup>3</sup>/h (A ventilation time of 77s)

### Weight

Net weight:440kg

Packing weight:542kg



Silent room



Soundproof



Acoustic panels



LED



110-240V



USB



# Solo

Unlike the Phone, which focuses only on call making , Solo can be used in a more integrated way, both as an enhanced Phone Booth and as a mobile work platform. The user feel free to stay in Solo all day with the help of the unique LED lighting and fresh air system .

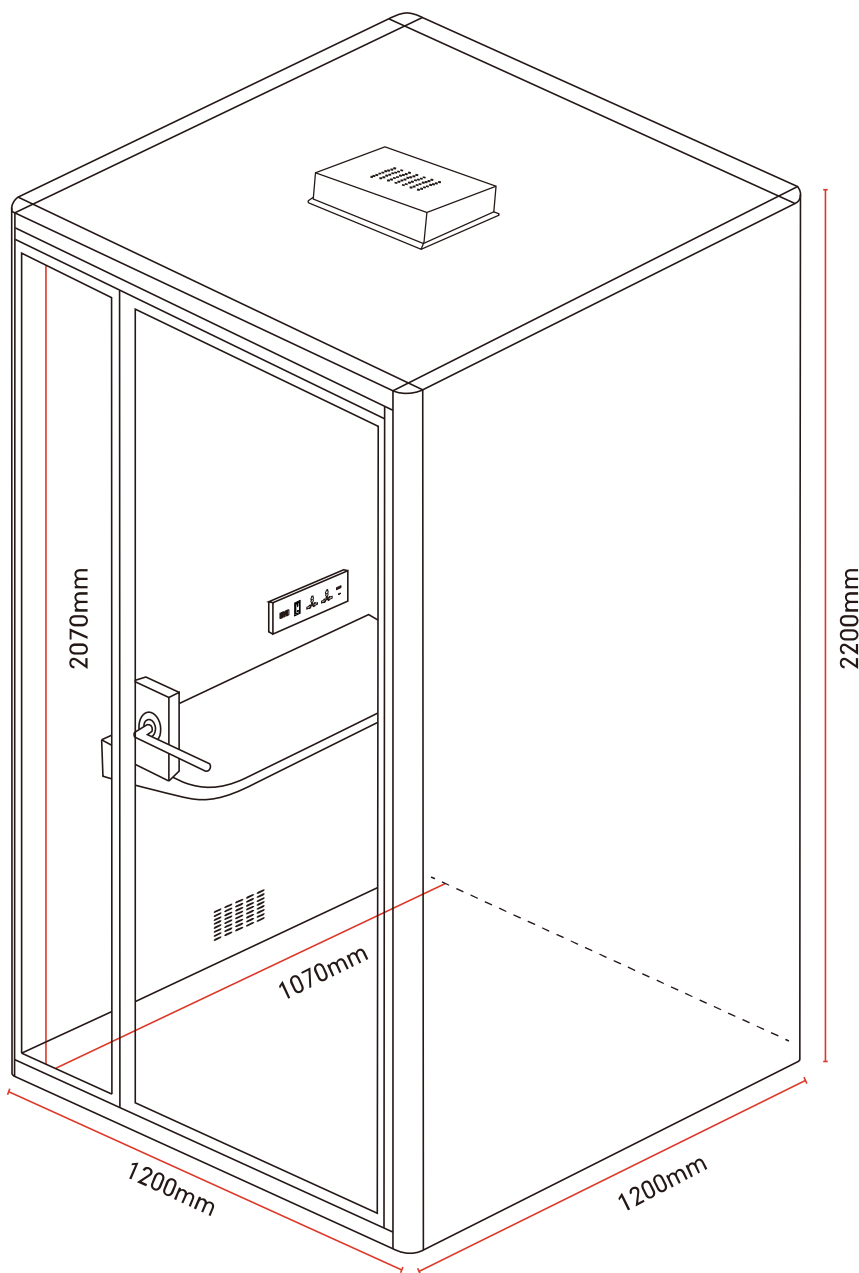

FRONT VIEW

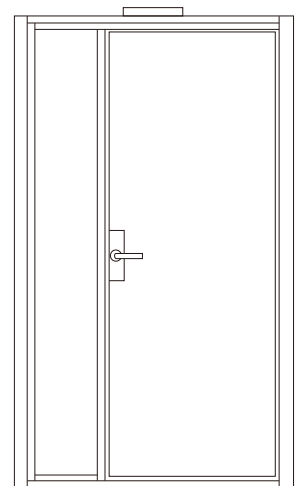

REAR VIEW

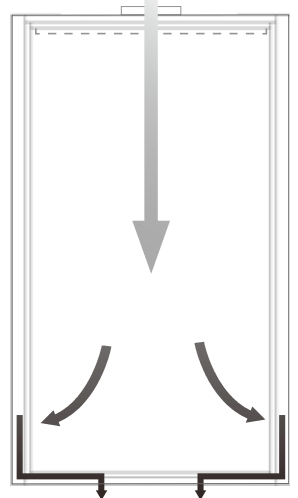

# Solo Plus



**Growing** up requires going through different stages of development, and when we rise to the role of manager, we will face more difficult problems, as well as a more spacious room for your personal studio.



---

Outer:W1750\*D1770\*H2200/2320mm  
Inner:W1620\*D1640\*H2070mm

## Vertical View

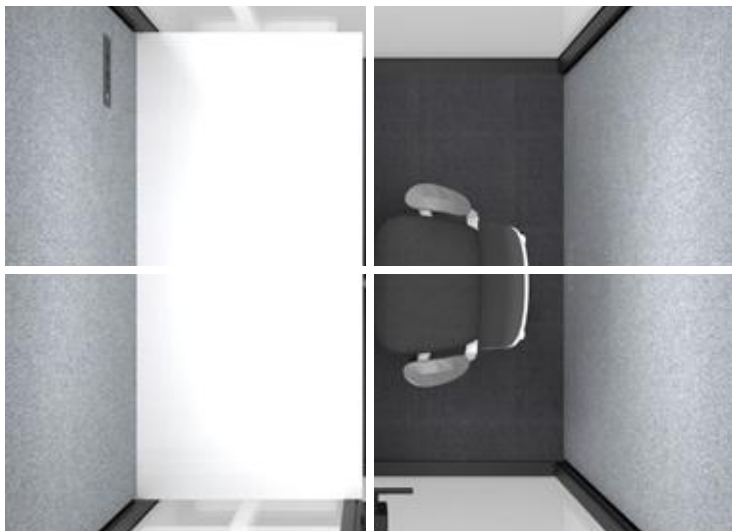

---

Unlike the Phone, which focuses only on call making, Solo Plus can be used in a more integrated way, both as an enhanced Phone Booth and as a mobile work platform. The user feel free to stay in Solo all day with the help of the unique LED lighting and fresh air system.

# Solo Plus

---

# Solo Plus

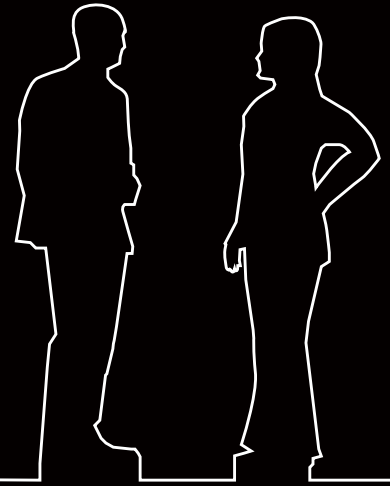
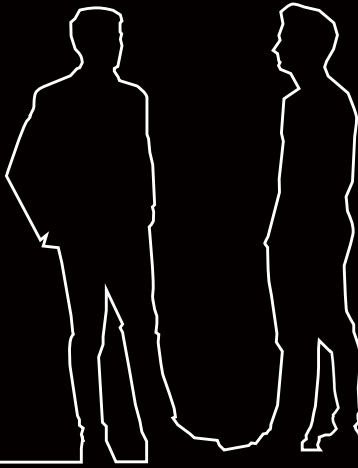

**Private**

**Quiet**

**Movable**

**Easy to Install**

**Quick shipment**

## Product info

### Size

Outer:W1750\*D1770\*H2200/2320mm

Inner:W1620\*D1640\*H2070mm

Packing / Volume: W2300\*D1250\*H1200 mm /3.57m<sup>3</sup>

### Other

Without table, chair

### Ceiling/Floor

Aluminum frame; Integrated ceiling with inner regular color PET;

Movable bottom with carpet

### Wall/Door

SideA1/C1: steel panel with same color of frame; SideA2/C2: PET acoustic panel;  
side B:11mm laminated glass, side D :11mm laminated glass with hidden frame  
door (Optional concealed door closer)

### Lighting

18W strip light at 2 sides; 18W strip light in the middle of ceiling; Motion sensor for ventilation fan and atmosphere light. Default delay of 5 minutes for automatic off.

### Control

Including integrated switch panel system(Default physical switch controls main lighting);  
Optional central control panel system.





### Fresh air

180m<sup>3</sup>/h (A ventilation time of 87s)

### Weight

Net weight:670kg

Packing weight:820kg

-  Silent room
-  Soundproof
-  Acoustic panels
-  LED
-  110-240V
-  USB



# Solo Plus

Unlike the Phone, which focuses only on call making, Solo Plus can be used in a more integrated way, both as an enhanced Phone Booth and as a mobile work platform. The user feel free to stay in Solo all day with the help of the unique LED lighting and fresh air system.

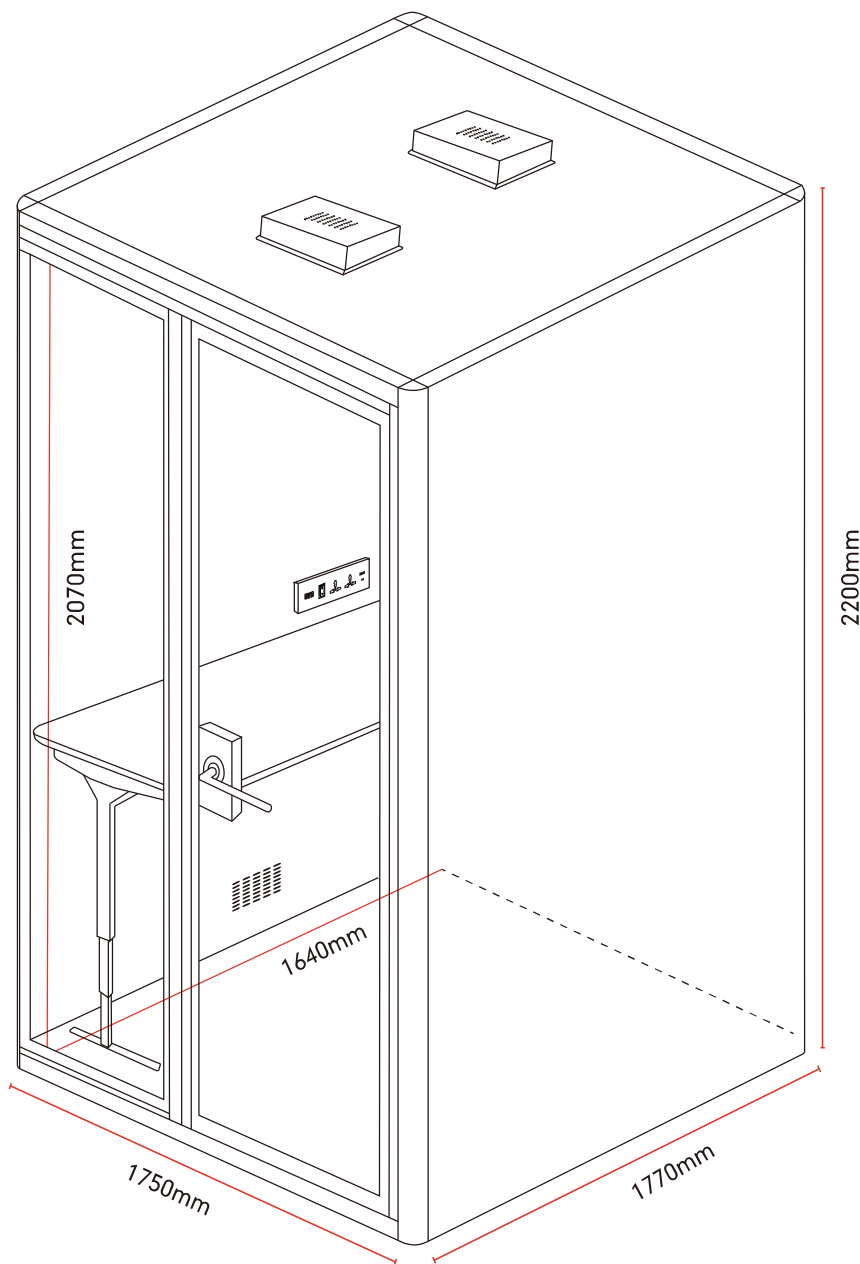

FRONT VIEW

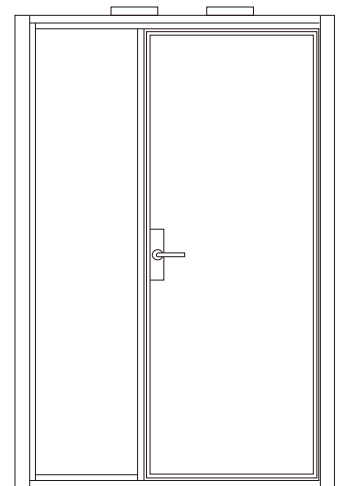

REAR VIEW

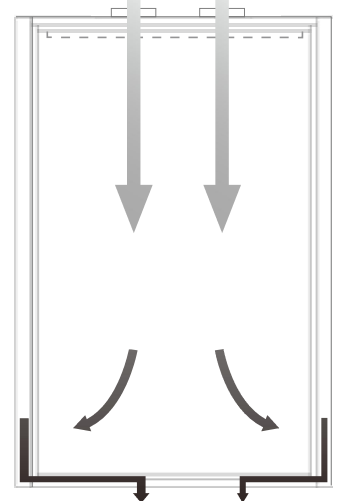

# Live



**LEISURE** time, get your little hobbies, youth!

Right now, in the era of information, making live stream or short videos becomes a daily routine. Create a space, “Live” is the best innovative place.



Outer:W1575\*D1200\*H2200/2320mm  
Inner:W1445\*D1070\*H2070mm

## Vertical View

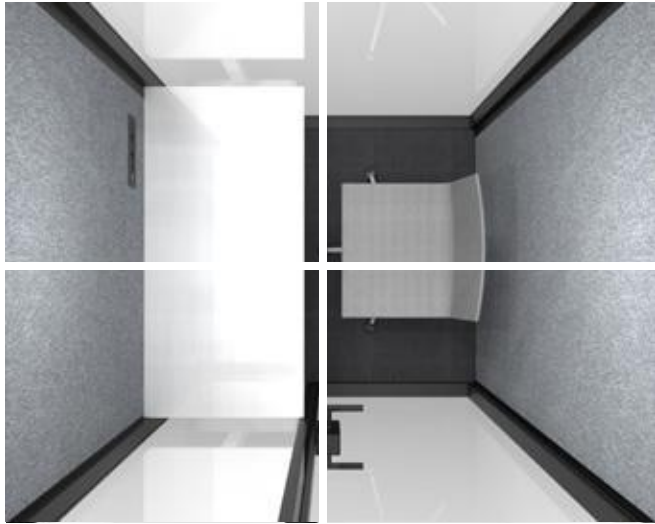

“Live” is designed for information workers. Double side glass can provide sufficient working space and good daylighting which are enough to meet the requirements of live commerce, live teaching, etc. With excellent sound insulation system, you can focus on your own workspace without any disturbance. After finishing live stream, it will become your office to solve all the follow-up work. Changing between in front of or behind the scenes at will.

# Live

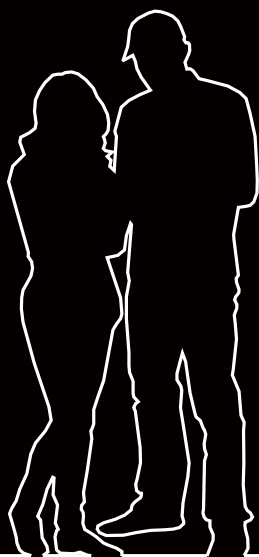

**Private**

**Quiet**

**Movable**

**Easy to Install**

**Quick shipment**

## Product info

### Size

Outer:W1575\*D1200\*H2200/2320mm

Inner:W1445\*D1070\*H2070mm

Packing / Volume:W2300\*D840\*H1400 mm /2.8m<sup>3</sup>

### Other

Without table, chair

### Ceiling/Floor

Aluminum frame; Integrated ceiling with inner regular color PET;

Movable bottom with carpet

### Wall/Door

SideA1/C1: steel panel with same color of frame; SideA2/C2: PET acoustic panel;

side B:11mm laminated glass, side D :11mm laminated glass with hidden frame door (Optional concealed door closer)

### Lighting

12W strip light at 2 sides; 12W strip light in the middle of ceiling; Motion sensor for ventilation fan and atmosphere light. Default delay of 5 minutes for automatic off.

### Control

Including integrated switch panel system(Default physical switch controls main lighting);

Optional central control panel system.

### Fresh air

180m<sup>3</sup>/h (A ventilation time of 65s)

### Weight

Net weight:517kg

Packing weight:615kg



Silent room



Soundproof



Acoustic panels



LED



110-240V



USB



# Live

“Live” is designed for information workers. Double side glass can provide sufficient working space and good daylighting, With excellent sound insulation system, you can focus on your own workspace without any disturbance.

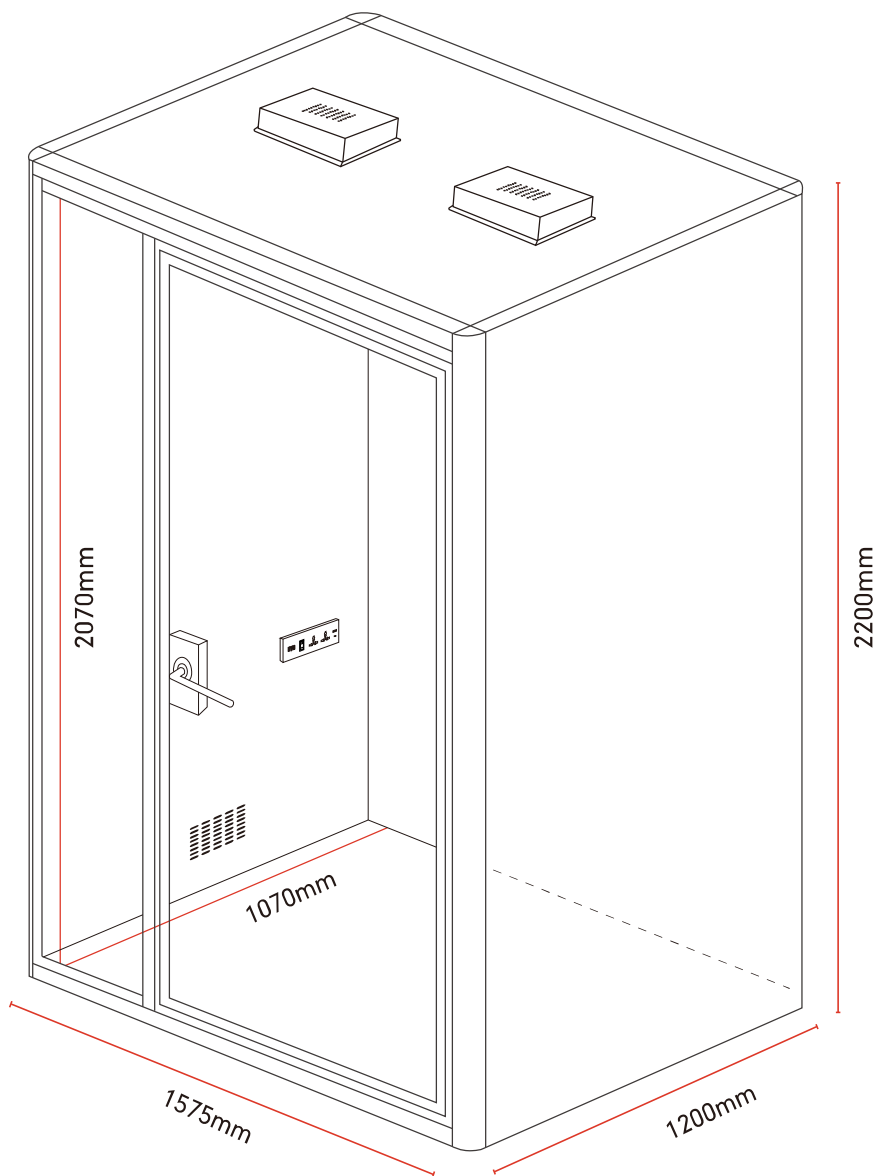

FRONT VIEW

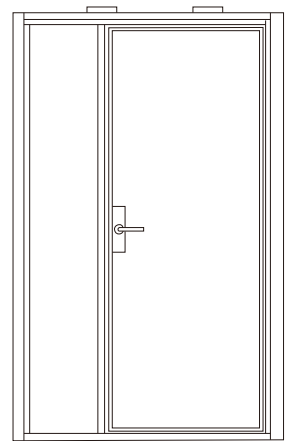

REAR VIEW

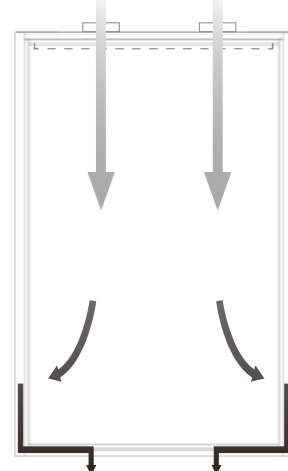

# Relax



**TAKE** a break from your busy schedule to wrap up your recent work, be excited for your team to win the sales title this quarter and think up a great idea for the upcoming family day of your company. Just relax as what it should be.



Outer:W1575\*D1200\*H2200/2320mm  
Inner:W1445\*D1070\*H2070mm

## Vertical View

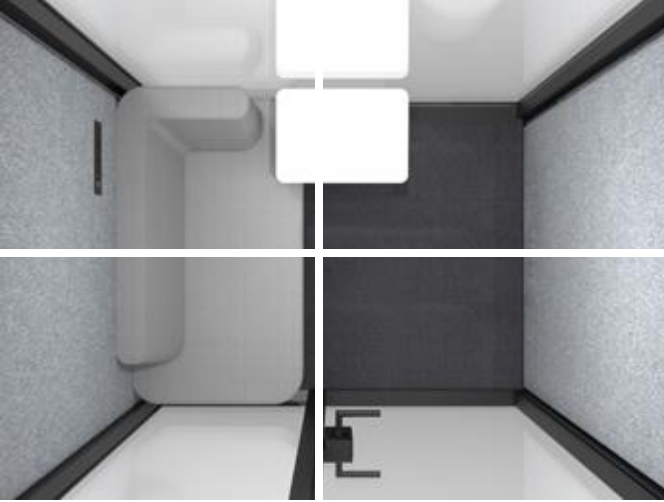

Modern workplace is a gladiatorial field, practitioners in the face of a wide variety of work pressure. It is possible to create a sanctuary in the existing office space where employees can relieve their stress and find the best working conditions when they feel depressed and helpless. So Relax comes into being, where you can find your most authentic self and your best channel to connect with the world.

# Relax

# Relax



**Private**

**Quiet**

**Movable**

**Easy to Install**

**Quick shipment**

## Product info

### Size

Outer:W1575\*D1200\*H2200/2320mm

Inner:W1445\*D1070\*H2070mm

Packing / Volume: W2300\*D840\*H1400 mm /2.8m<sup>3</sup>

### Other

Without teapoy, sofa

### Ceiling/Floor

Aluminum frame; Integrated ceiling with inner regular color PET;

Movable botton with carpet

### Wall/Door

SideA1/C1: steel panel with same color of frame; SideA2/C2: PET acoustic panel;  
side B:11mm laminated glass, side D :11mm laminated glass with hidden frame  
door (Optional concealed door closer)

### Lighting

12W strip light at 2 sides; 12W strip light in the middle of ceiling; Motion sensor for ventilation fan and atmosphere light. Default delay of 5 minutes for automatic off.

### Control

Including integrated switch panel system(Default physical switch controls main lighting);  
Optional central control panel system.

### Fresh air

180m<sup>3</sup>/h (A ventilation time of 65s)

### Weight

Net weight:517kg

Packing weight:615kg



Silent room



Soundproof



Acoustic panels



LED



110-240V



USB



# Relax

Relax and Solo are the similar size . The main differences between the two are the different furniture specification .

Relax helps you to find your most authentic self and your best channel to connect with the world.

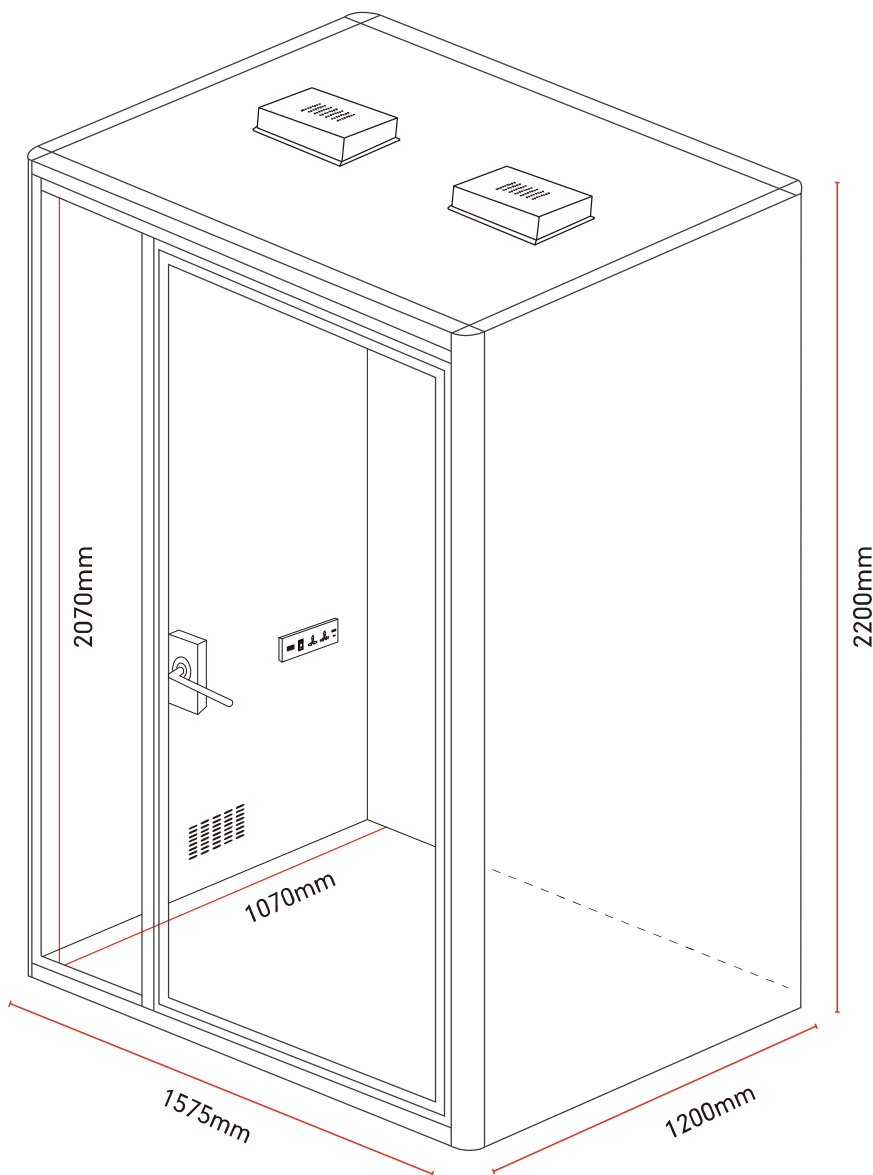

FRONT VIEW

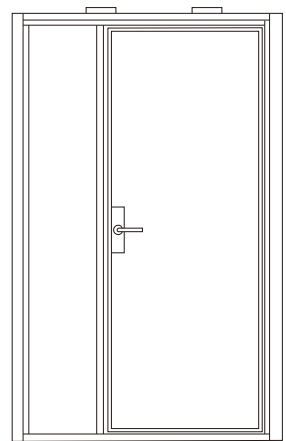

REAR VIEW

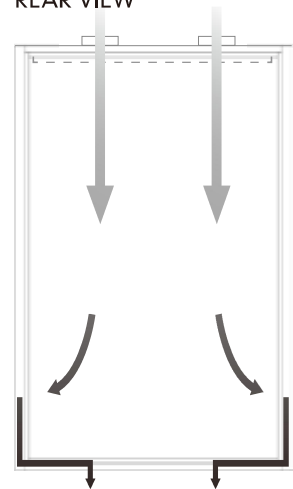

# Chat



**NOWADAYS, both work and life are very tight;**

**A space for chatting may be able to alleviate it in a short period of time;**

**Have a chat, there must also be unexpected gains!**



Outer:W1575\*D1200\*H2200/2320mm  
Inner:W1445\*D1070\*H2070mm

## Vertical View

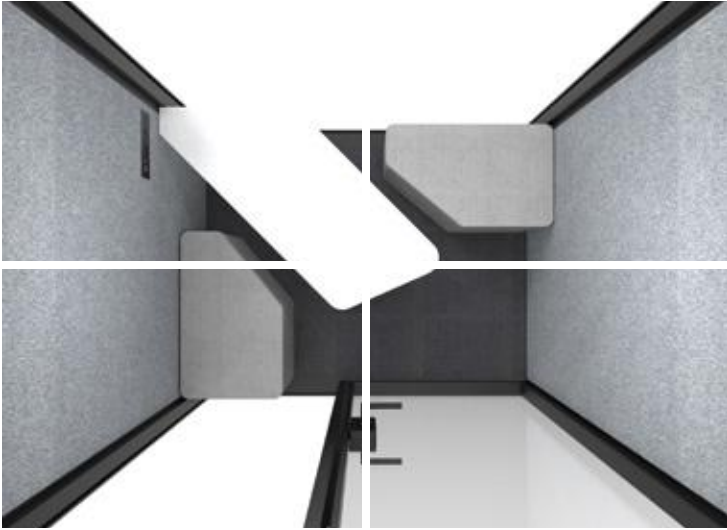

Not all meetings or communications in the workplace are serious. For instance, communicating project details with clients, discussing work status with subordinates, or brainstorming solutions with colleagues. You need a space for face-to-face communication. CHAT, get it!

# Chat

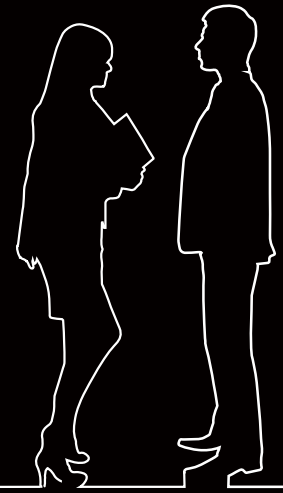
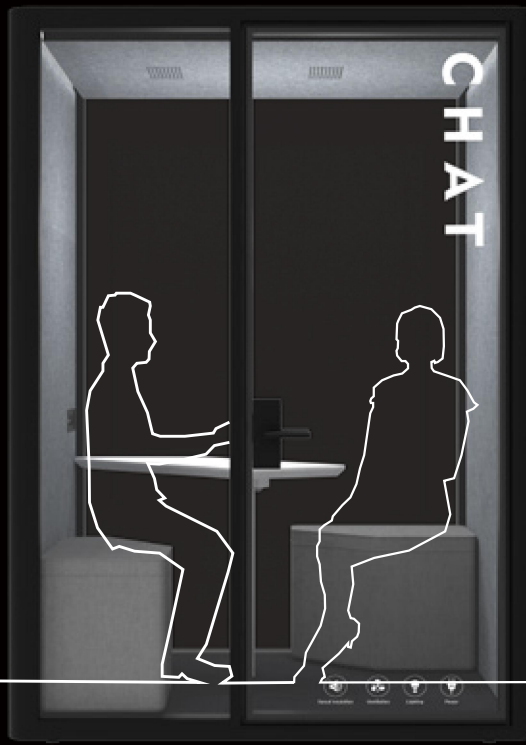
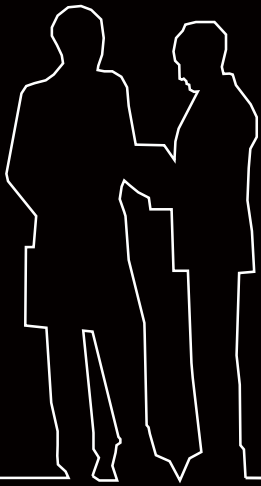

**Private**

**Quiet**

**Movable**

**Easy to Install**

**Quick shipment**

## Product info

### Size

Outer:W1575\*D1200\*H2200/2320mm

Inner:W1445\*D1070\*H2070mm

Packing / Volume: W2300\*D840\*H1400 mm /2.8m<sup>3</sup>

### Other

Without table, chair

### Ceiling/Floor

Aluminum frame; Integrated ceiling with inner regular color PET;

Movable bottom with carpet

### Wall/Door

SideA1/C1: steel panel with same color of frame; SideA2/C2: PET acoustic panel;

side B:11mm laminated glass, side D :11mm laminated glass with hidden frame door (Optional concealed door closer)

### Lighting

12W strip light at 2 sides; 12W strip light in the middle of ceiling; Motion sensor for ventilation fan and atmosphere light. Default delay of 5 minutes for automatic off.

### Control

Including integrated switch panel system(Default physical switch controls main lighting);

Optional central control panel system.







### Fresh air

180m<sup>3</sup>/h (A ventilation time of 65s)

### Weight

Net weight:517kg

Packing weight:615kg

-  Silent room
-  Soundproof
-  Acoustic panels
-  LED
-  110-240V
-  USB



# Chat

Not all meetings or communications in the workplace are serious. For instance, communicating project details with clients, discussing work status with subordinates, or brainstorming solutions with colleagues. You need a space for face-to-face communication. CHAT, get it!

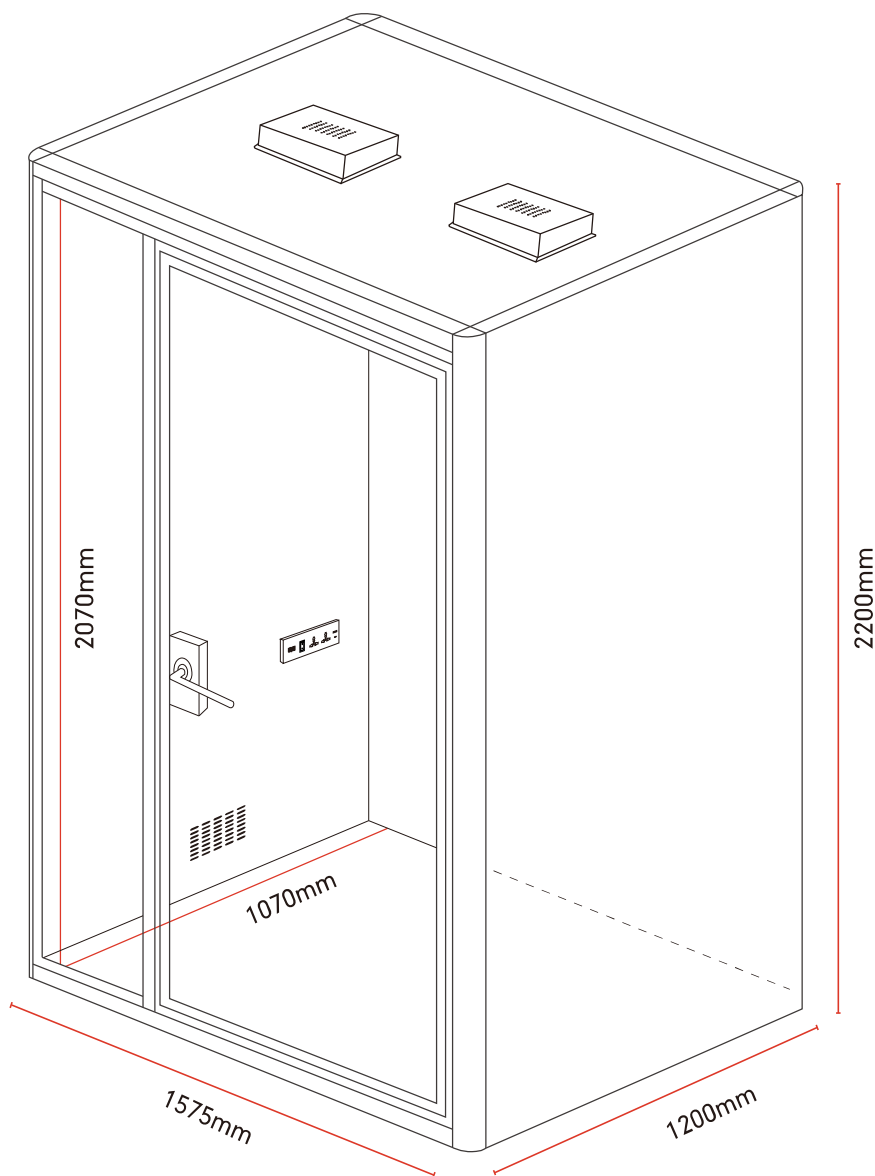

FRONT VIEW

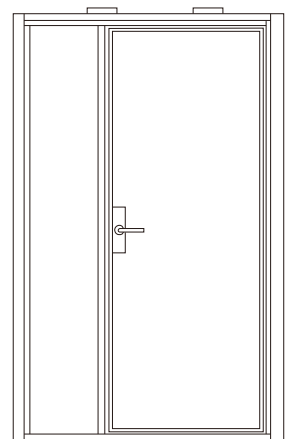

REAR VIEW

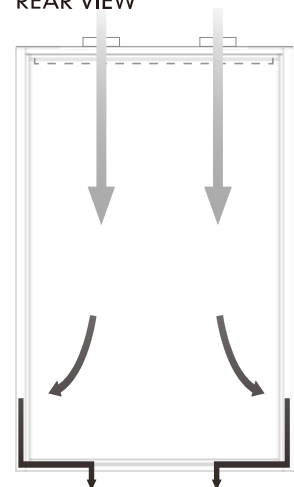

# Cowork



**LOOK** forward to the bright future together with your Coworker.

Never do we feel so needed till we find the perfect partner. In the past few years,co-working space is on the continuous rise and people hunger for cooperation than any other time before.



---

Outer:W1750\*D1200\*H2200/2320mm  
Inner:W1620\*D1070\*H2070mm

## Vertical View

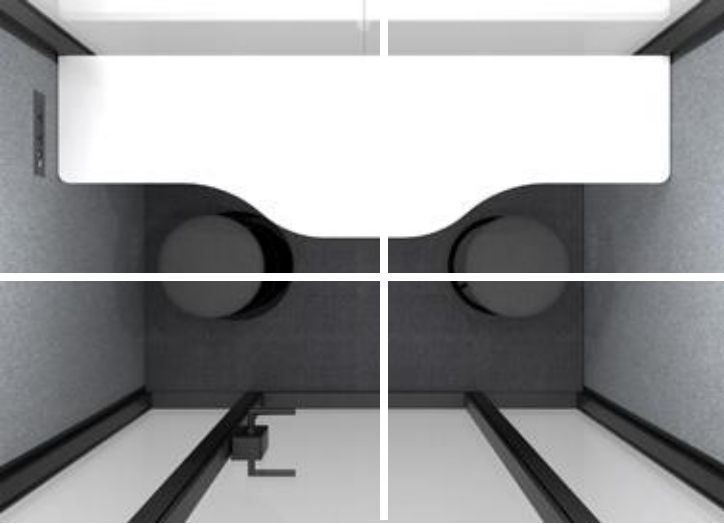

---

Cowork collection is designed for couple workshop . In modern office space , the concept of coworking has never been more deeply and frequently mentioned , and UVO gives it a whole new definition . The precise electronic and sound insulation system secure smooth discussion of co-workers without being disturbed by the surrounding . Art Cutting shape of the table, close the distance between each other,in a relaxed and harmonious atmosphere,the completion of efficient, pleasant communication.

---

# Cowork



**Private**

**Quiet**

**Movable**

**Easy to Install**

**Quick shipment**

## Product info

### Size

Outer:W1750\*D1200\*H2200/2320mm

Inner:W1620\*D1070\*H2070mm

Packing / Volume: W2300\*D840\*H1400 mm /2.8m<sup>3</sup>

### Other

Including table; Without chair

### Ceiling/Floor

Aluminum frame; Integrated ceiling with inner regular color PET;

Movable botton with carpet

### Wall/Door

SideA1/C1: steel panel with same color of frame; SideA2/C2: PET acoustic panel;

side B:11mm laminated glass, side D :11mm laminated glass with hidden frame door (Optional concealed door closer)

### Lighting

12W strip light at 2 sides; 15W strip light in the middle of ceiling; Motion sensor for ventilation fan and atmosphere light. Default delay of 5 minutes for automatic off.

### Control

Including integrated switch panel system(Default physical switch controls main lighting);

Optional central control panel system.

### Fresh air

180m<sup>3</sup>/h (A ventilation time of 65s)

### Weight

Net weight:565kg

Packing weight:675kg

 Silent room

 Soundproof

 Acoustic panels

 LED

 110-240V

 USB



# Cowork

Cowork collection is designed for couple workshop . The precise electronic and sound insulation system secure smooth discussion of co-workers without being disturbed by the surrounding. Art Cutting shape of the table, close the distance between each other, in a relaxed and harmonious atmosphere the completion of efficient, pleasant communication.

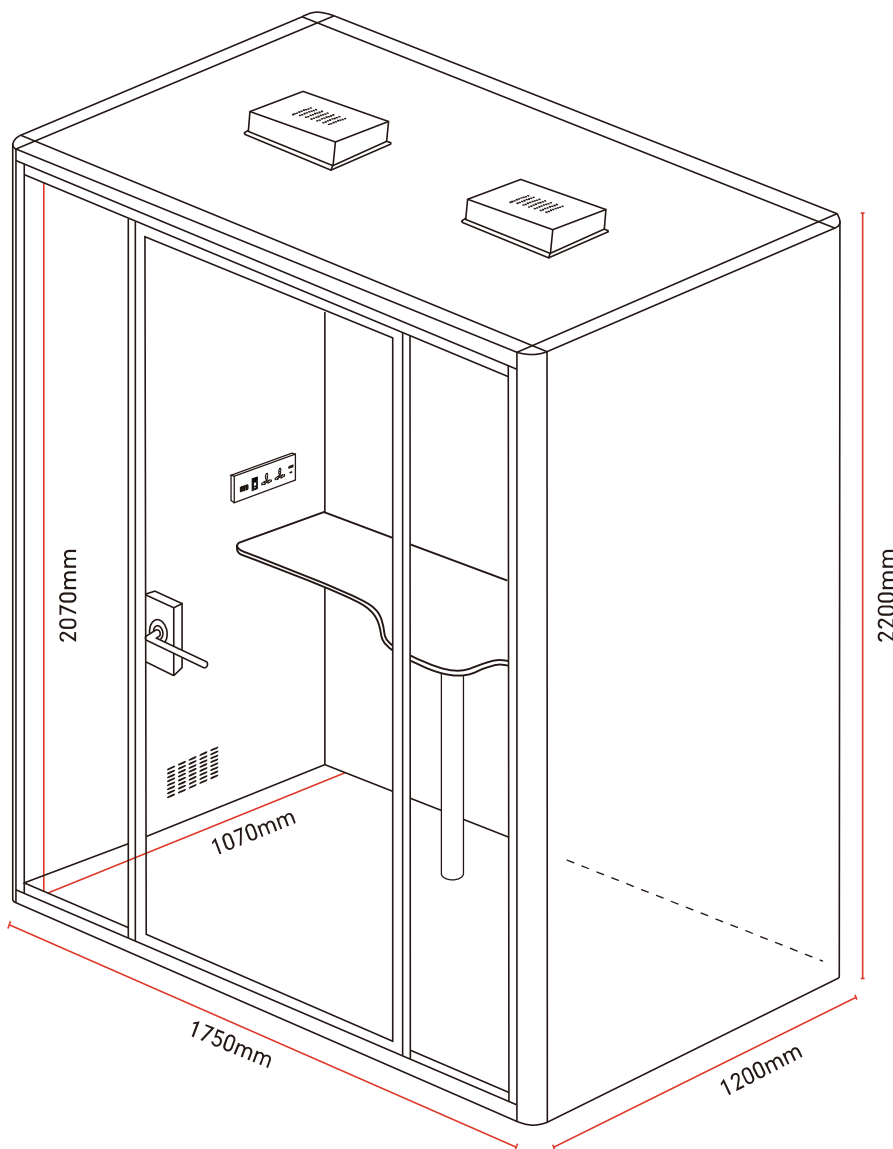

FRONT VIEW

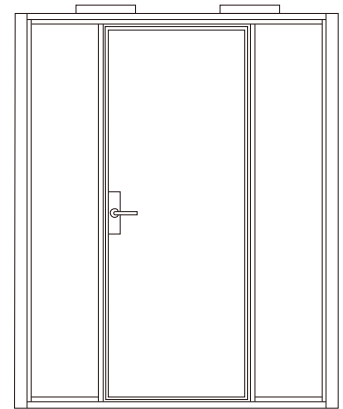

REAR VIEW

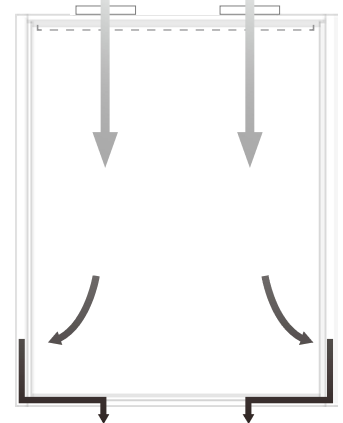

# Talk



**FACE-to-face is the best way to communicate, perhaps we have forgotten how long ago the last long Talk , This is where the Spiritual Talk begins.**



Outer:W2200\*D1200\*H2200/2320mm  
Inner:W2070\*D1070\*H2070mm

## Vertical View

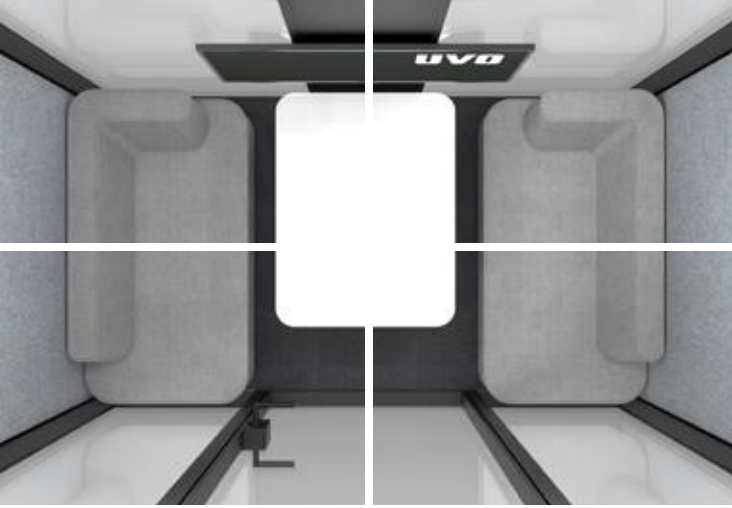

Talk is more functional intensive than any other models. The intelligent control system helps the meeting to be high efficient, so that communication is not hindered, and the thinking collides with brilliant sparks. The professional lighting system guarantees the extreme visual experience of the users in each position of the space, and the sound insulation system keeps the work undisturbed. Talk can meet the needs of up to four people and will be the most versatile product in terms of size and functionality.

# Talk

# Talk

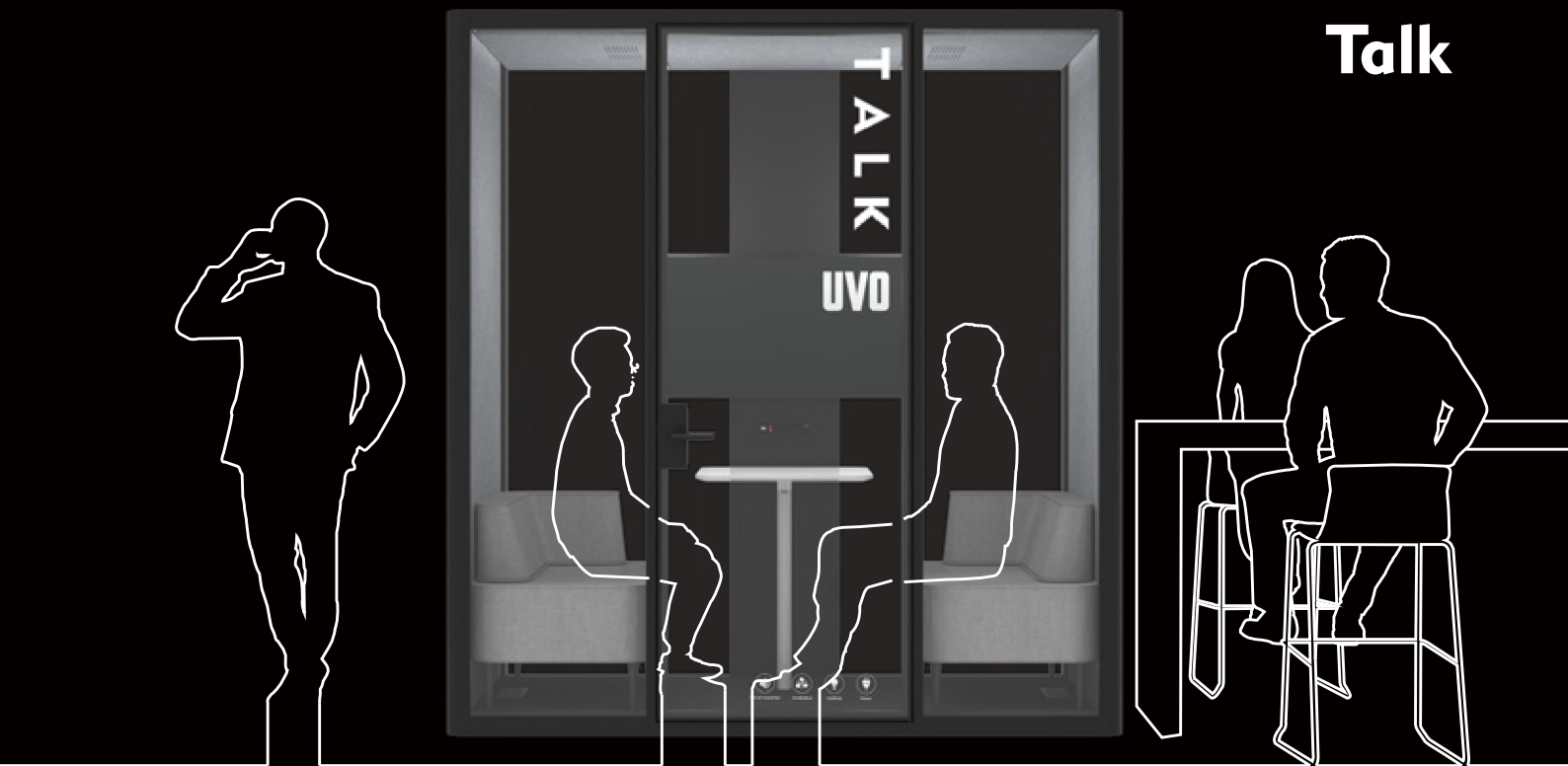

**Private**

**Quiet**

**Movable**

**Easy to Install**

**Quick shipment**

## Product info

### Size

Outer:W2200\*D1200\*H2200/2320mm

Inner:W2070\*D1070\*H2070mm

Packing / Volume: W2300\*D840\*H1400 mm /2.8m<sup>3</sup>

### Other

Including table; Without displayer, sofa

### Ceiling/Floor

Aluminum frame; Integrated ceiling with inner regular color PET;

Movable bottom with carpet

### Wall/Door

SideA1/C1: steel panel with same color of frame; SideA2/C2: PET acoustic panel;

side B:11mm laminated glass, side D :11mm laminated glass with hidden frame door (Optional concealed door closer)

### Lighting

12W strip light at 2 sides; 2\*12W strip light in the middle of ceiling; Motion sensor for ventilation fan and atmosphere light. Default delay of 5 minutes for automatic off.

### Control

Including integrated switch panel system(Default physical switch controls main lighting);

Optional central control panel system.







### Fresh air

180m<sup>3</sup>/h (A ventilation time of 75s)

### Weight

Net weight:630kg

Packing weight:780kg

-  Silent room
-  Soundproof
-  Acoustic panels
-  LED
-  110-240V
-  USB



# Talk

Talk is more functional intensive than any other models. The intelligent control system helps the meeting to be high efficient , so that communication is not hindered, and the thinking collides with brilliant sparks. It can meet the needs of up to four people and will be the most versatile product in terms of size and functionality.

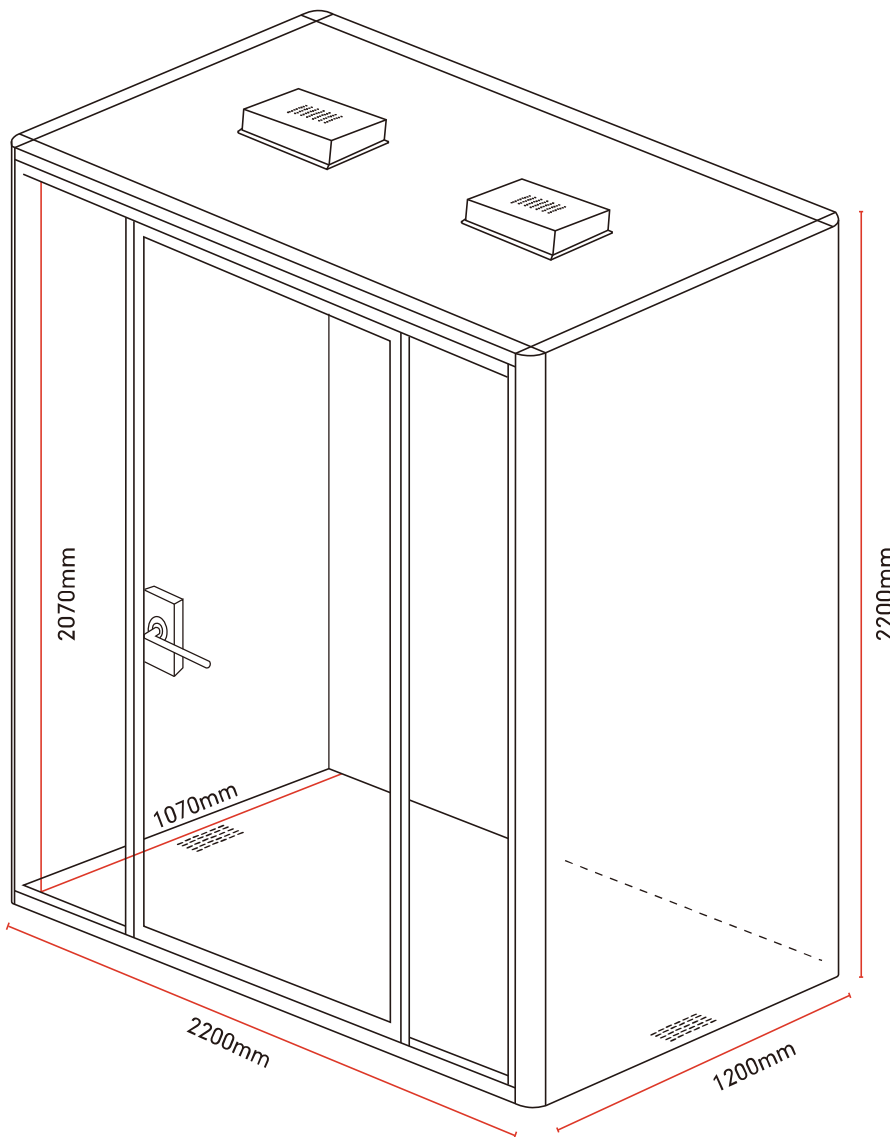

FRONT VIEW

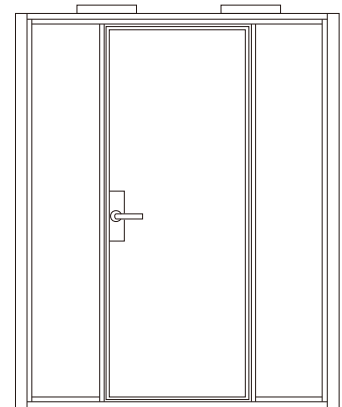

REAR VIEW

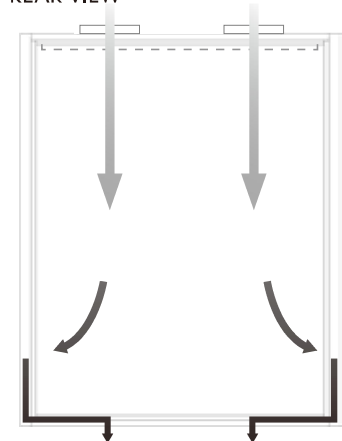

# Talk Plus



**THINK** in the way that your team is thinking. Ideas are warmly discussed and completely integrated in the Talk Plus. It's the best place to enjoy the fulfilment of success with your teammates.



Outer:W2200\*D1500\*H2200/2320mm  
Inner:W2070\*D1370\*H2070mm

## Vertical View

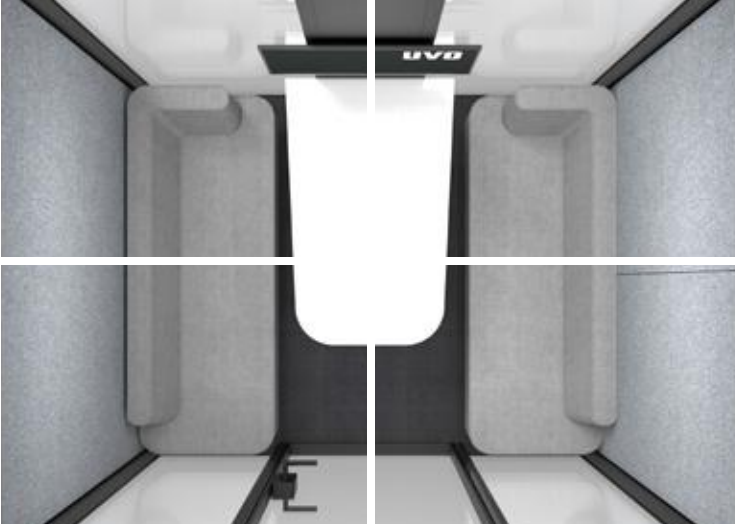

Talk Plus is more functional intensive than any other models. The intelligent control system helps the meeting to be high efficient, so that communication is not hindered, and the thinking collides with brilliant sparks. The professional lighting system guarantees the extreme visual experience of the users in each position of the space, and the sound insulation system keeps the work undisturbed.

Talk Plus can meet the needs of up to four people and will be the most versatile product in terms of size and functionality.

# Talk Plus

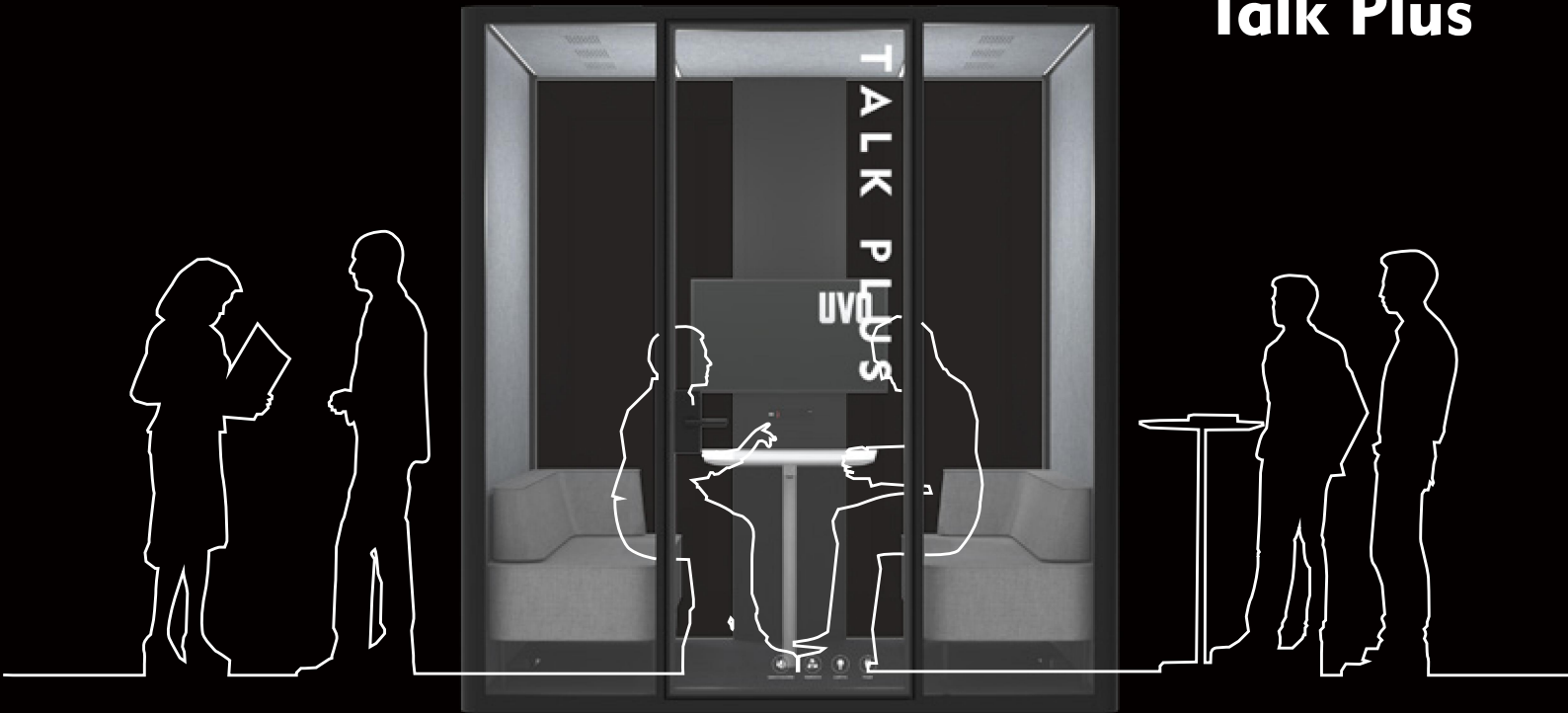

**Private**

**Quiet**

**Movable**

**Easy to Install**

**Quick shipment**

## Product info

### Size

Outer:W2200\*D1500\*H2200/2320mm

Inner:W2070\*D1370\*H2070mm

Packing / Volume: W2300\*D1250\*H1200 mm /3.67m<sup>3</sup>

### Other

Including table, Without displayer, sofa

### Ceiling/Floor

Aluminum frame; Integrated ceiling with inner regular color PET;

Movable bottom with carpet

### Wall/Door

SideA1/C1: steel panel with same color of frame; SideA2/C2: PET acoustic panel;

side B:11mm laminated glass, side D :11mm laminated glass with hidden frame door (Optional concealed door closer)

### Lighting

15W strip light at 2 sides; 2\*15W strip light in the middle of ceiling; Motion sensor for ventilation fan and atmosphere light. Default delay of 5 minutes for automatic off.

### Control

Including integrated switch panel system(Default physical switch controls main lighting);

Optional central control panel system.

### Fresh air

420m<sup>3</sup>/h(A ventilation time of 54s)

### Weight

Net weight:860kg

Packing weight:950kg



Silent room



Soundproof



Acoustic panels



LED



110-240V



USB



# Talk Plus

Talk Plus is more functional intensive than any other models. The intelligent control system helps the meeting to be high efficient , so that communication is not hindered, and the thinking collides with brilliant sparks. It can meet the needs of up to four people and will be the most versatile product in terms of size and functionality.

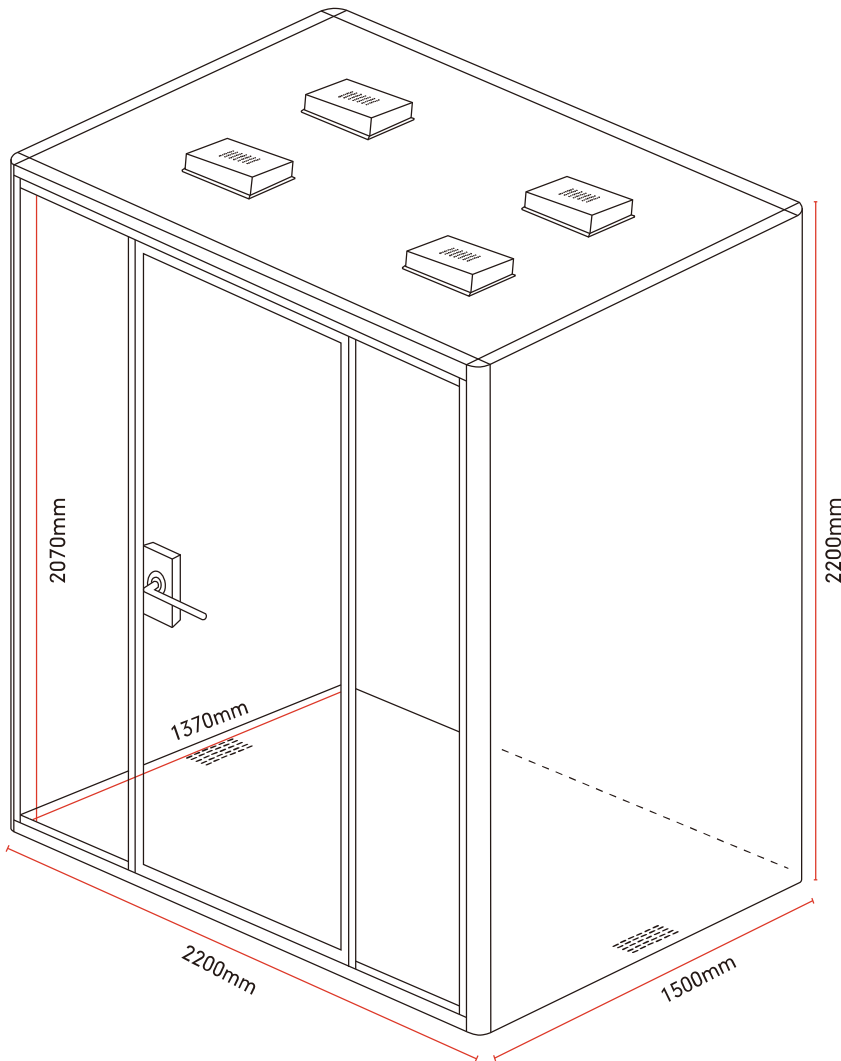

FRONT VIEW

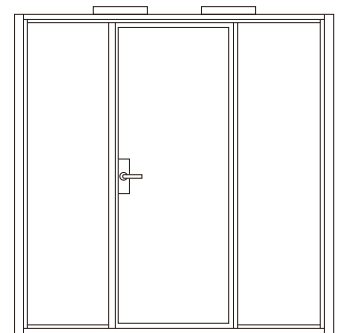

REAR VIEW

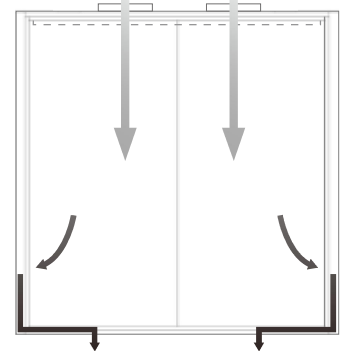

# Meeting



**WITHOUT** restraint and freely expressing views. "Meeting" is to  
enough produce so many R & D plans, create directions and  
planning schemes, achieve countless successful cases.



Outer:W2200\*D1770\*H2200/2320mm  
Inner:W2070\*D1640\*H2070mm

## Vertical View

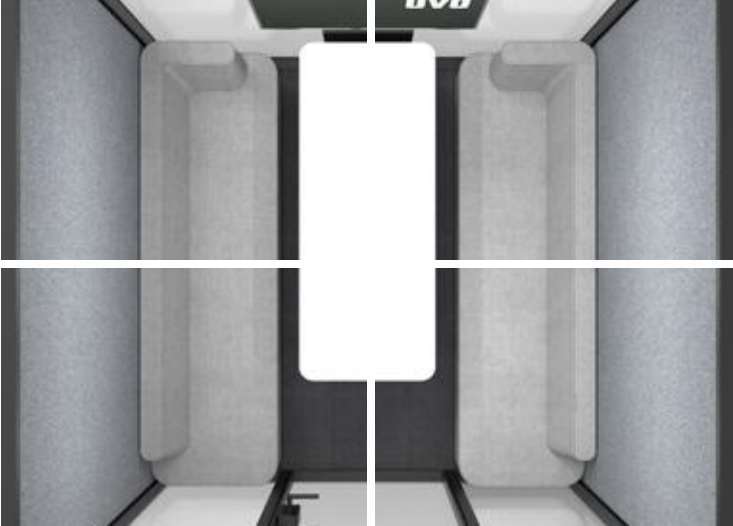

“Meeting”, Bigger space, offering more possibilities which can accommodate at least 6 people. You can define it at will, It can satisfy all of your needs.

# Meeting

# Meeting

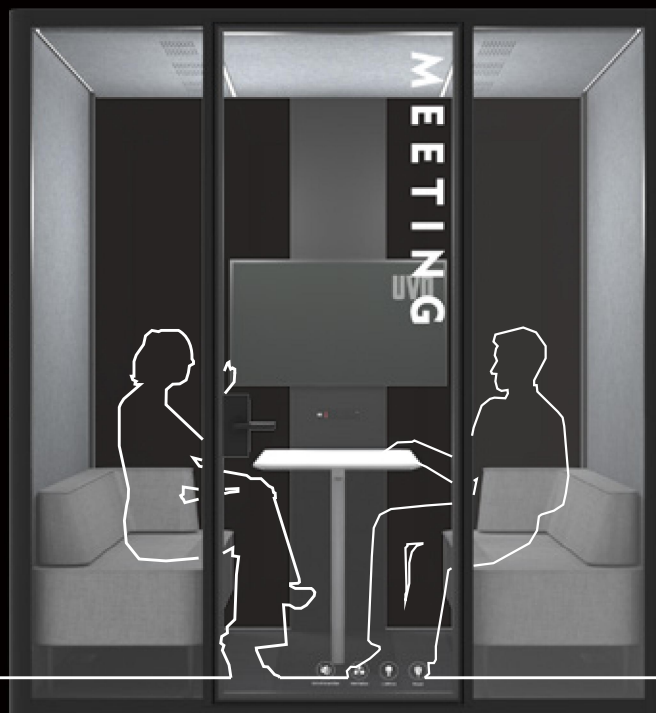

**Private**

**Quiet**

**Movable**

**Easy to Install**

**Quick shipment**

## Product info

### Size

Outer:W2200\*D1770\*H2200/2320mm

Inner:W2070\*D1640\*H2070mm

Packing / Volume: W2300\*D1250\*H1200 mm /3.67m<sup>3</sup>

### Other

Including table; Without displayer, sofa

### Ceiling/Floor

Aluminum frame; Integrated ceiling with inner regular color PET;

Movable bottom with carpet

### Wall/Door

SideA1/C1: steel panel with same color of frame; SideA2/C2: PET acoustic panel;

side B:11mm laminated glass, side D :11mm laminated glass with hidden frame door (Optional concealed door closer)

### Lighting

18W strip light at 2 sides; 2\*18W strip light in the middle of ceiling; Motion sensor for ventilation fan and atmosphere light. Default delay of 5 minutes for automatic off.

### Control

Including integrated switch panel system(Default physical switch controls main lighting);

Optional central control panel system.







### Fresh air

420m<sup>3</sup>/h (A ventilation time of 76s)

### Weight

Net weight:880kg

Packing weight:1030kg

-  Silent room
-  Soundproof
-  Acoustic panels
-  LED
-  110-240V
-  USB



# Meeting

“Meeting”, Bigger space, offering more possibilities which can accommodate at least 6 people. You can define it at will, It can satisfy all of your needs.

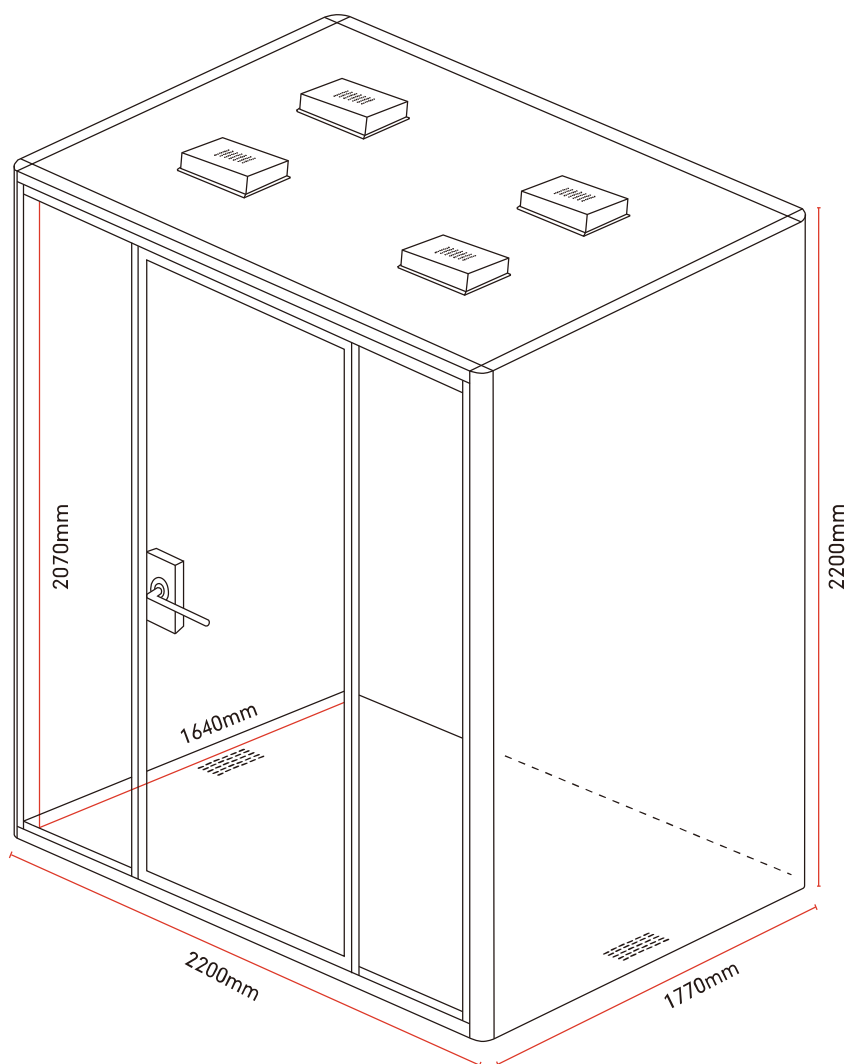

FRONT VIEW

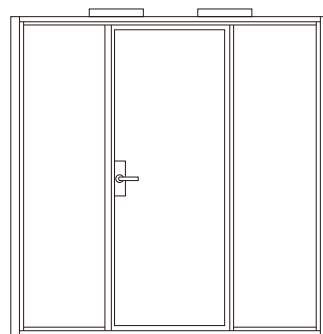

REAR VIEW

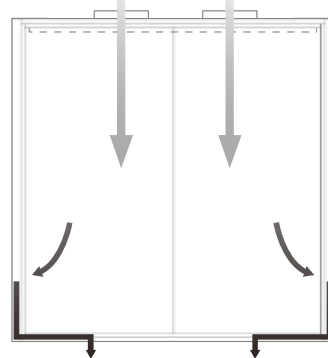

# Meeting BF



**CARING** for special groups and incorporating social responsibility into design concepts,  
Even with limited mobility, it can still be unobstructed.



---

Outer:W2200\*D1770\*H2200/2320mm  
Inner:W2070\*D1640\*H2070mm

## Vertical View



---

Caring for special groups and incorporating social responsibility into design concepts,  
Even with limited mobility, it can still be unobstructed.

# Meeting BF

# Meeting BF

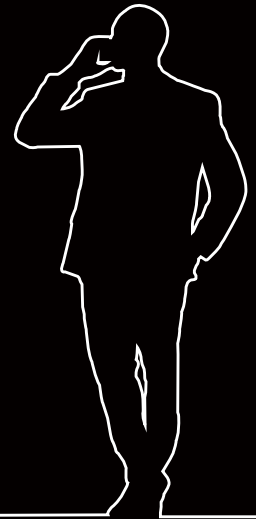

**Private**

**Quiet**

**Movable**

**Easy to Install**

**Quick shipment**

## Product info

### Size

Outer:W2200\*D1770\*H2200/2320mm

Inner:W2070\*D1640\*H2070mm

Packing / Volume: W2300\*D1250\*H1200 mm /3.67m<sup>3</sup>

### Other

Without table

### Ceiling/Floor

Aluminum frame; Integrated ceiling with inner regular color PET;

Movable bottom with carpet

### Wall/Door

SideA1/C1: steel panel with same color of frame; SideA2/C2: PET acoustic panel;

side B:11mm laminated glass, side D :11mm laminated glass with hidden frame

door (Optional concealed door closer)

### Lighting

18W strip light at 2 sides; 2\*18W strip light in the middle of ceiling; Motion sensor for ventilation fan and atmosphere light. Default delay of 5 minutes for automatic off.

### Control

Including integrated switch panel system(Default physical switch controls main lighting);

Optional central control panel system.

### Fresh air

420m<sup>3</sup>/h (A ventilation time of 76s)

### Weight

Net weight:790kg

Packing weight:940kg



Silent room



Soundproof



Acoustic panels



LED



110-240V



USB



# Meeting BF

Caring for special groups and incorporating social responsibility into design concepts,

Even with limited mobility, it can still be unobstructed.

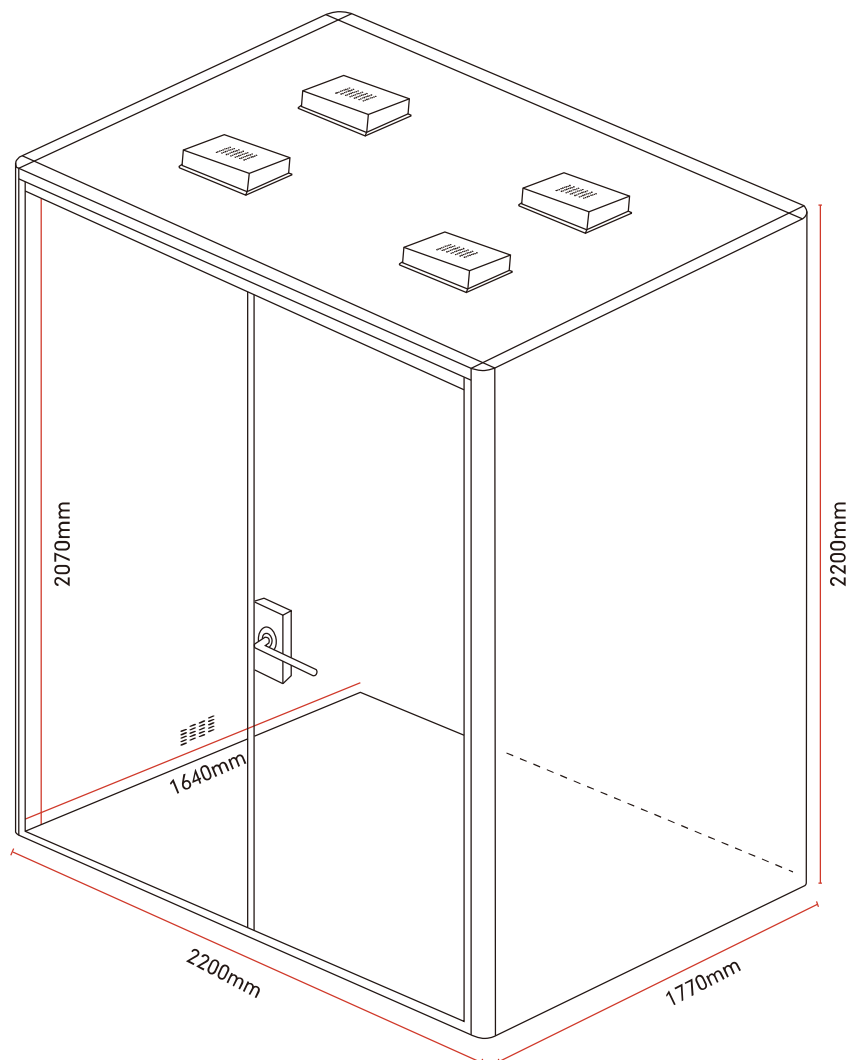

FRONT VIEW

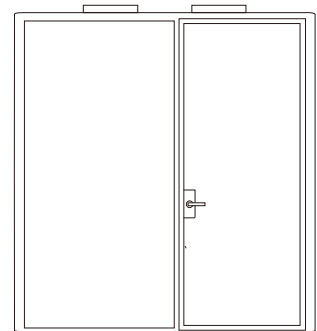

REAR VIEW

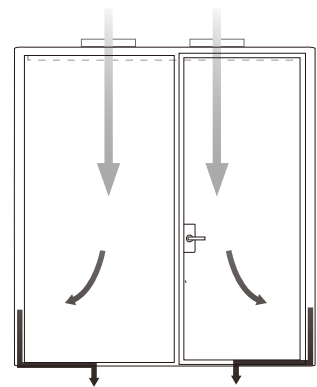

# Meeting Plus

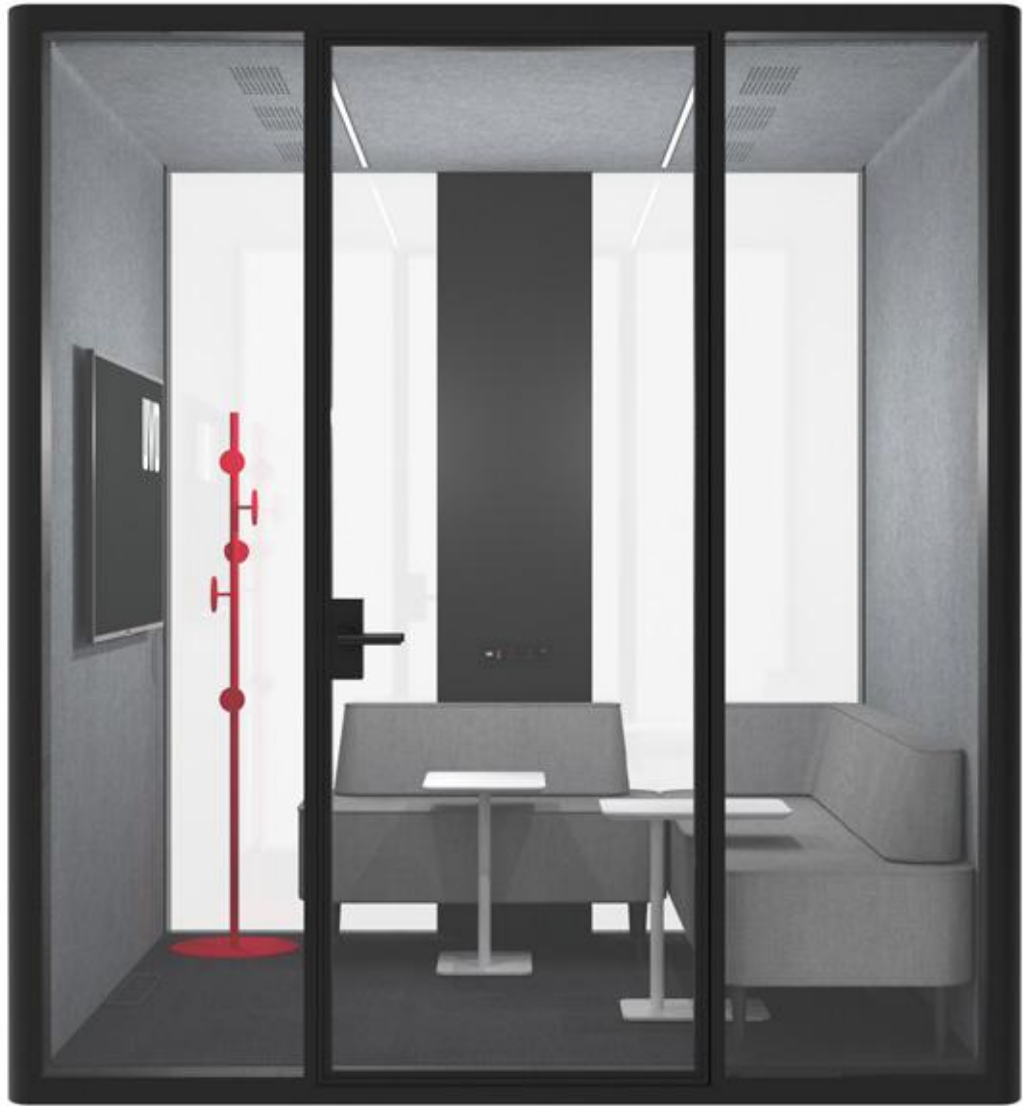

**MEETINGS** mustn't be formal, Comfortable and casual rooms may unleash more inspiration, "Meeting Plus", more space, more imagination!



---

Outer:W2200\*D2200\*H2200/2320mm  
Inner:W2070\*D2070\*H2070mm

## Vertical View

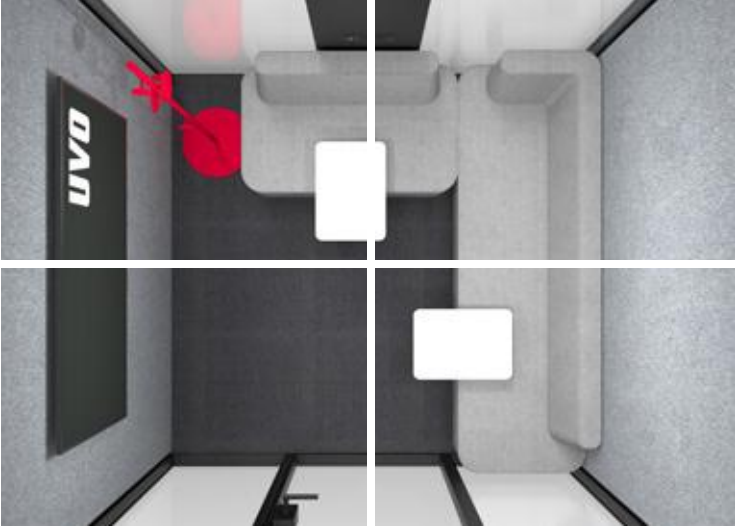

---

Meeting Plus, Bigger Space, Greater Imagination!  
With our spacious meeting rooms, your imagination knows no bounds. Whether it's innovative discussions, team collaborations, or critical decision-making, we create the ideal environment for you.

# Meeting Plus |

# Meeting Plus

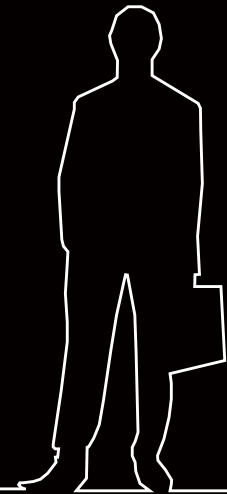
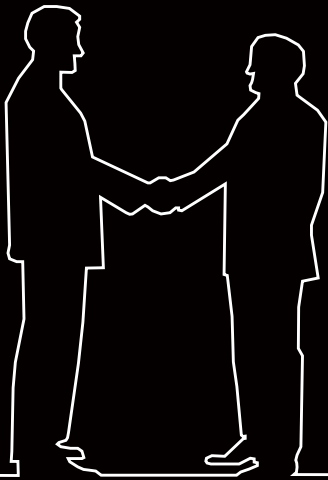

**Private**

**Quiet**

**Movable**

**Easy to Install**

**Quick shipment**

## Product info

### Size

Outer:W2200\*D2200\*H2200/2320mm

Inner:W2070\*D2070\*H2070mm

Packing / Volume: W2300\*D1350\*H1400 mm /4.5m<sup>3</sup>

### Other

Without sofa, teapoy, displayer, wave

### Ceiling/Floor

Aluminum frame; Integrated ceiling with inner regular color PET;

Movable botton with carpet

### Wall/Door

SideA1/C1: steel panel with same color of frame; SideA2/C2: PET acoustic panel;

side B:11mm laminated glass, side D :11mm laminated glass with hidden frame door (Optional concealed door closer)

### Lighting

23W strip light at 2 sides; 2\*23W strip light in the middle of ceiling; Motion sensor for ventilation fan and atmosphere light.Default delay of 5 minutes for automatic off.

### Control

Including integrated switch panel system(Default physical switch controls main lighting);

Optional central control panel system.

### Fresh air

420m<sup>3</sup>/h (A ventilation time of 75s)

### Weight

Net weight:1030kg

Packing weight:1150kg



Silent room



Soundproof



Acoustic panels



LED



110-240V



USB



# Meeting Plus

Meeting Plus, Bigger Space, Greater Imagination!

With our spacious meeting rooms, your imagination knows no bounds.

Whether it's innovative discussions, team collaborations, or critical decision-making, we create the ideal environment for you.

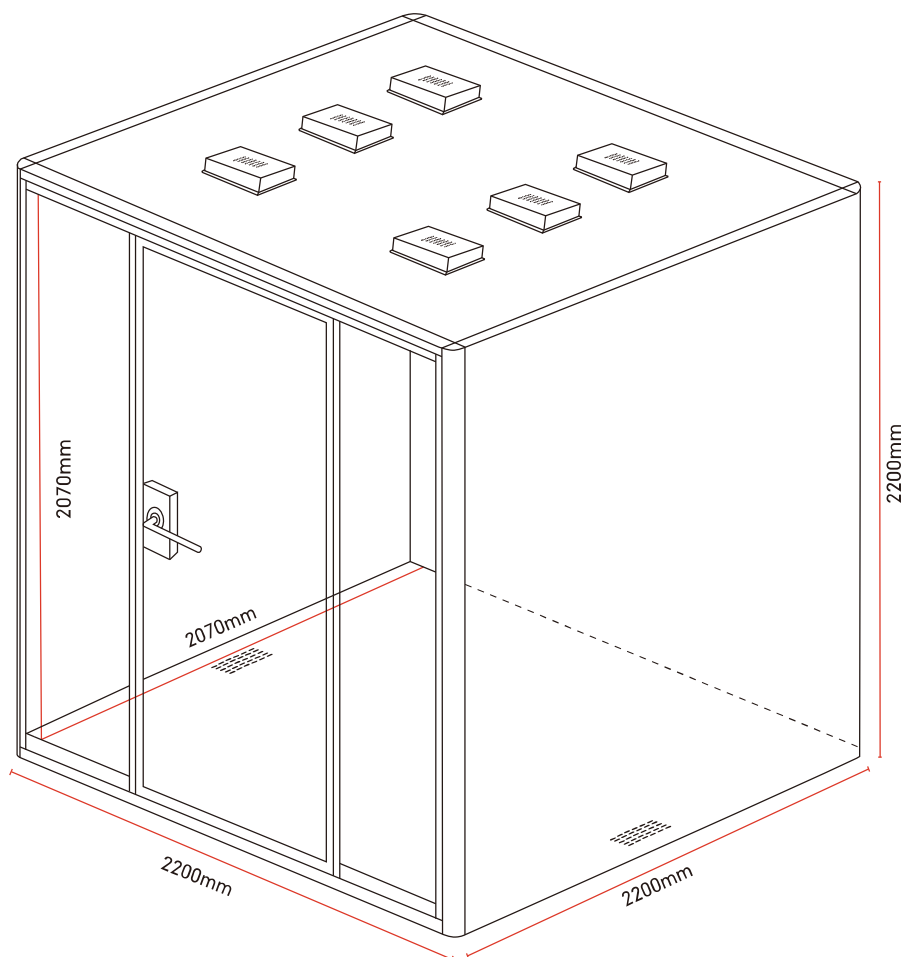

FRONT VIEW

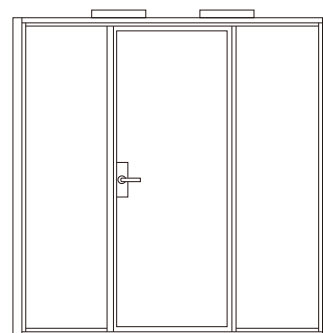

REAR VIEW

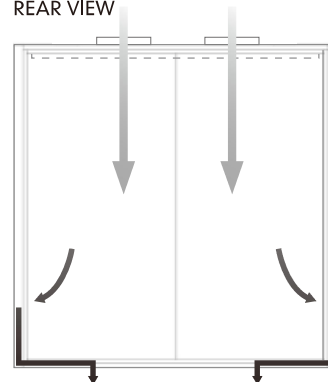

# Conference



**CONFERENCE**, A true conference room, Enough space for standing and sitting, Even during long meetings, one can adjust their posture at any time to improve work efficiency.



---

Outer:W2400\*D2400\*H2200/2320mm  
Inner:W2270\*D2270\*H2070mm

## Vertical View

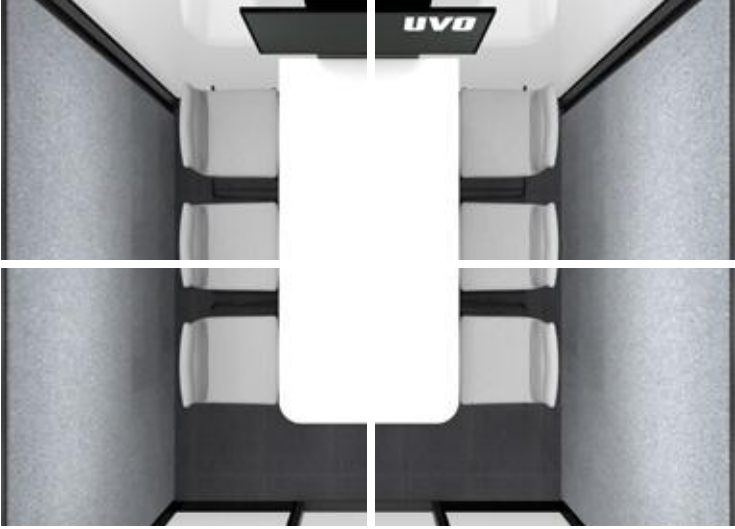

---

Conference, currently the largest model in the standard range, can accommodate meetings with 6-10 people. The conference table and chairs are designed with a high stance, allowing for adjustable seating positions according to the nature of the meeting, achieving the utmost comfort.

---

# Conference

---

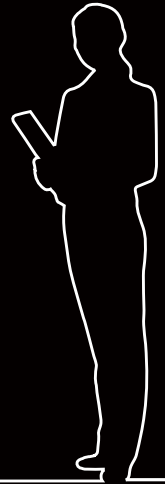
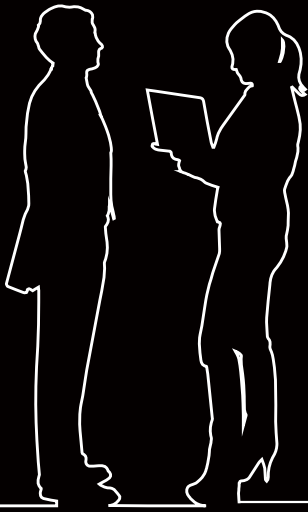

**Private**

**Quiet**

**Movable**

**Easy to Install**

**Quick shipment**

## Product info

### Size

Outer:W2400\*D2400\*H2200/2320mm

Inner:W2270\*D2270\*H2070mm

Packing / Volume: W2530\*D1520\*H1400 mm /5.34m<sup>3</sup>

### Other

Including table; Without displayer, chair

### Ceiling/Floor

Aluminum frame; Integrated ceiling with inner regular color PET;

Movable bottom with carpet

### Wall/Door

SideA1/C1: steel panel with same color of frame; SideA2/C2: PET acoustic panel;

side B:11mm laminated glass, side D :11mm laminated glass with hidden frame door (Optional concealed door closer)

### Lighting

25W strip light at 2 sides; 2\*25W strip light in the middle of ceiling; Motion sensor for ventilation fan and atmosphere light. Default delay of 5 minutes for automatic off.

### Control

Including integrated switch panel system(Default physical switch controls main lighting);

Optional central control panel system.

### Fresh air

630m<sup>3</sup>/h (A ventilation time of 77s)

### Weight

Net weight:1130kg

Packing weight:1260kg



Silent room



Soundproof



Acoustic panels



LED



110-240V



USB







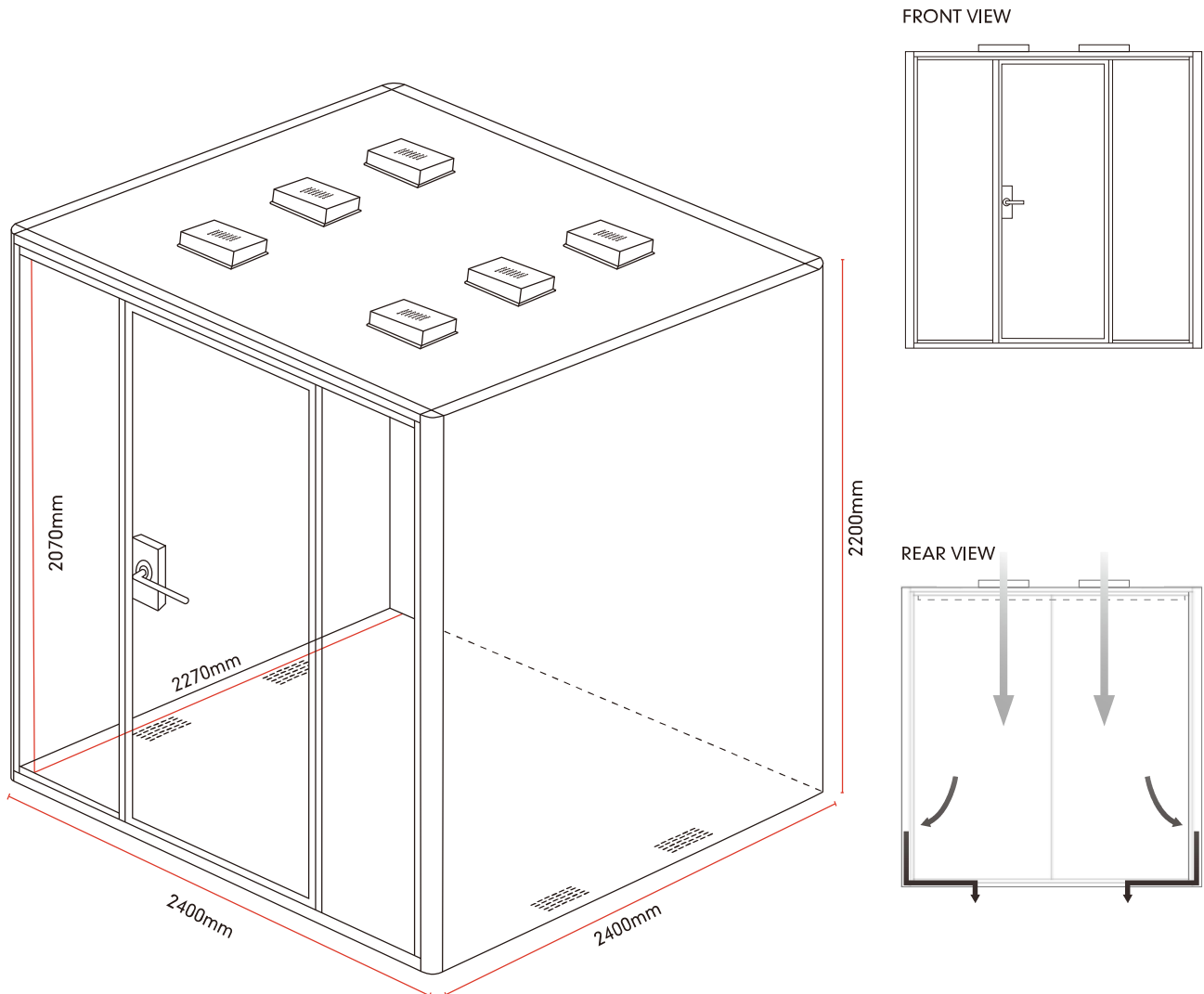





# Conference





Conference, currently the largest model in the standard range, can accommodate meetings with 6-10 people. The conference table and chairs are designed with a high stance, allowing for adjustable seating positions according to the nature of the meeting, achieving the utmost comfort.



# Accessories

Picture	Item/Description
	<p><b>Teapoy</b></p> <p>Size W420* D350* H500 mm</p> <p>Weight 7.5kg</p> <p>Material Metal tripod+White fireproof board countertop with painted beveled edges</p>
	<p><b>Bookshelf</b></p> <p>Size W1018* D31* H180 mm</p> <p>Surface treatment Metal electrostatic powder spraying</p> <p>Material Metal</p>
	<p><b>Honeywell Concealed Door Closer</b></p> <p>Size W425* H60 mm</p> <p>Material Aluminium Alloy</p> <p>Maximum opening angle 135°</p>
	<p><b>Status Light</b></p> <p>Size Customize styles and sizes</p> <p>Material Luminescent character</p> <p>Thickness 8cm / 2cm(Magnetic suction)</p>
	<p><b>Xiaomi Monitor</b></p> <p>Size 32cun</p> <p>Material Full Metal Screen</p>
	<p>Size 43cun</p> <p>Material Full Metal Screen</p>
	<p><b>TV Rack A</b></p> <p>Size (Applicable TV size) W520* H425 mm (26-55 inches)</p> <p>Material Metal</p> <p>Load-bearing 50kg</p>
	<p><b>TV Rack B</b></p> <p>Size (Applicable TV size) W430* H430 mm (22-55 inches)</p> <p>Material SPCC Cold Rolled Steel</p> <p>Load-bearing 35kg</p>
	<p><b>86 Panel</b></p> <p>Size W85* H85 mm</p> <p>Panel standard Standard national ,Optional standards in "Optional Socket Panel"</p>
	<p><b>Time Control Box</b></p> <p>Size W250* D120 * H30 mm</p> <p>Rated current 3A</p> <p>Rated voltage 220V</p>
	<p><b>Broken Windows Hammer A</b></p> <p>Size W95* H150 mm</p> <p>Material ABS+Carbon Steel</p>
	<p><b>Broken Windows Hammer B</b></p> <p>Size W228* D80 mm</p> <p>Material ABS+45# carbon steel</p>

# Accessories

Picture	Item/Description
	<p><b>Pillow</b></p> <p>Size W400* H400 mm</p> <p>Surface material Korean satin</p> <p>Internal material Environmentally friendly non-woven fabric+high elasticity PP cotton</p>
	<p><b>Hooks</b></p> <p>Size W16* D31* H40 mm</p> <p>Surface treatment Baked black paint</p> <p>Material Refined brass</p>
	<p><b>Coat Hanger</b></p> <p>Size W410* D150* H2 mm</p> <p>Surface treatment Metal electrostatic powder spraying</p> <p>Material Metal</p>
	<p><b>Wave</b></p> <p>Size D360* H1800 mm</p> <p>Surface treatment Metal electrostatic powder spraying</p> <p>Material Metal</p>

# Standard Integrated Control Panel

<p>Universal Strong Electric Panel*2</p> <p>Main Lighting Physical Switch Panel*1</p> <p>USB / Type-C Panel*1</p>	<p>Motion sensor for ventilation and mood lighting. (Default delay of 5 minutes for automatic off) , Integrated switch panel system( Standard with 1 Main lighting physical switch+2 universal strong electric sockets +1USB+type-C sockets)</p>
---	--

## Optional Panel

Picture	Item/Description
<p>Universal Strong Electric Panel*1</p> <p>Main Lighting Regulating Panel*1</p> <p>Fan/ Atmosphere lighting Regulating Panel*1</p> <p>USB / Type-C Panel*1</p>	<p>Motion sensor and switch control for ventilation and light. Default delay of 5 minutes for automatic off, Central control panel system (fresh air+lighting strength control, 1 universal strong electric socket+ 1 USB+type-C sockets), Automatic ventilation system with clock (automatic 5-minute indoor and outdoor air exchange every 30 minutes)</p> <p>Total load 200W / Residual load 100W</p>

<p>Default Universal socket</p> <p>China standard</p> <p>British standard</p> <p>Japanese standard</p> <p>American standard</p> <p>Australian standard</p> <p>German standard</p> <p>Large South Africa standard</p> <p>Danish standard</p> <p>Legal standard</p> <p>Brazil standard</p> <p>Swiss standard</p> <p>European standard German standard</p> <p>Argentina standard</p> <p>Israel standard</p> <p>Italian standard</p>	<h3>Optional Socket Panel</h3> <p>Optional sockets: China standard, British standard, Japanese standard, American standard, Australian standard, German standard, Large South Africa standard, Danish standard, Legal standard, Brazil standard, Swiss standard, European standard/German standard, Argentina standard, Israel standard, Italian standard, default universal socket</p>
--	---

	<h3>Telephone Outlet</h3> <p>Model RJ 11 CAT3</p> <p>Plugging times &gt;750times</p>
--	--

	<h3>Internet Outlet</h3> <p>Model RJ45</p> <p>Standard 23AWG Cat-6</p> <p>Transmission rate 1000Mbps</p>
--	--

	<h3>HDMI</h3> <p>Resolution ratio Support 720P, 1080P</p>
--	---

	<h3>USB+Type c</h3> <p>Maximum output 45w</p>
--	---

# Outer Color

## Frame & Panel

### Stock:



### Regular:

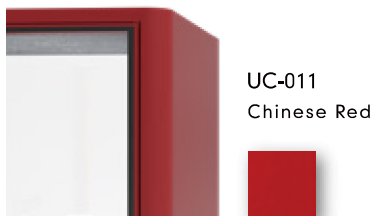
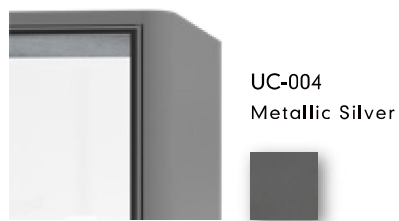

**Surface treatment:** Powdercoat

**Surface thickness:** 30-40um

**Environmental protection level:**

Fire-proof level: A

Formaldehyde emission: 0

# Inner Color

## Acoustic Panel ( PET )

### Stock:



### Regular:



**Surface treatment:** Mineral wool

**Thickness:** 9/12mm

**Environmental protection level:**

Fire-proof level: B1

Sound-absorbing: I

Formaldehyde emission: 0

# Fabric Color

**Brand:** OTE | **Series:** CUTE

## Stock:

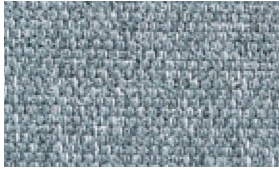

UFC-001  
Ultimate Grey

## Regular:



UFC-002  
Pink



UFC-003  
Yellow



UFC-004  
Caramel



UFC-005  
Green



UFC-006  
Blue

**Using range:** Sofas and chairs

**Fabric content:** 100%Polyester

## Characteristics:

Abrasion & Environmental protection

## Authentication:

OEKO-TEX® STANDARD 100



Please be aware that the color shades can appear different from the real fabric colors. We advise you to request actual fabric samples before ordering.

# Fabric Color

**Brand:** Gabriel | **Series:** Medley



UFC-011  
Light Grey



UFC-012  
Grey



UFC-013  
Camel



UFC-014  
Yellow



UFC-015  
Blue



UFC-016  
Green

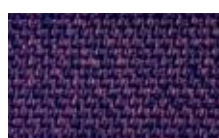

UFC-017  
Purple



UFC-018  
Red



UFC-019  
Orange



UFC-020  
Brown

**Using range:** Sofas and chairs

**Fabric content:** 100%Polyester

**Fire tests:** Class 2 Y

## **Characteristics:**

Abrasion & Environmental protection

Please be aware that the color shades can appear different from the real fabric colors. We advise you to request actual fabric samples before ordering.

# Carpet Color

**Brand:** MJL

**Stock:**

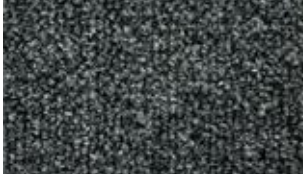

UCC-001  
Black

**Regular:**

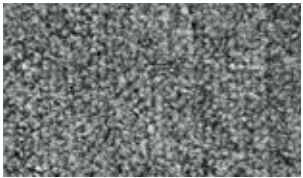

UCC-002  
Grey



UCC-003  
Camel



UCC-004  
Blue

**Using range:** Carpet

**Content:** 100%Nylon

**Thickness:** 7mm

**Environmental protection level:**

Fire-proof level: B1

Environmental testing: VOC A-level

Please be aware that the color shades can appear different from the real carpet colors. We advise you to request actual carpet samples before ordering.

# Recommend Collocation

## Stock:



**Inner Color:** Moonlight Ash  
**Outer Color:** Matt white



**Inner Color:** Moonlight Ash  
**Outer Color:** Matt black



**Inner Color:** Moonlight Ash  
**Outer Color:** Metallic silver



**Inner Color:** Silver Grey  
**Outer Color:** Matt white



**Inner Color:** Silver Grey  
**Outer Color:** Matt black



**Inner Color:** Silver Grey  
**Outer Color:** Metallic silver

## Regular:



**Inner Color:** Moonlight Ash  
**Outer Color:** Chinese red



**Inner Color:** Moonlight Ash  
**Outer Color:** Citrine



**Inner Color:** Moonlight Ash  
**Outer Color:** Summer blue



**Inner Color:** Sesame Black  
**Outer Color:** Matt white



**Inner Color:** Silver Grey  
**Outer Color:** Chinese red



**Inner Color:** Silver Grey  
**Outer Color:** Citrine



**Inner Color:** Silver Grey  
**Outer Color:** Summer blue



**Inner Color:** Sesame Black  
**Outer Color:** Matt black



**Inner Color:** Silver Grey  
**Outer Color:** Apricot Pink



**Inner Color:** Silver Grey  
**Outer Color:** Taro Purple



**Inner Color:** Silver Grey  
**Outer Color:** Avocado Green



**Inner Color:** Sesame Black  
**Outer Color:** Metallic silver

Natural color plate is recommended for the product color matching, specific please determine according to the product type;The above color matching is for reference only, all in kind prevail.